

Assembly instruction

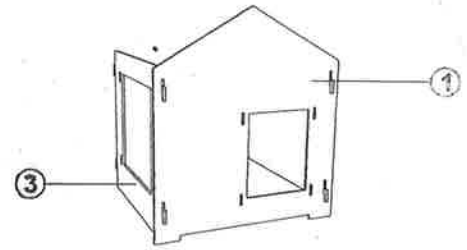

Step 1

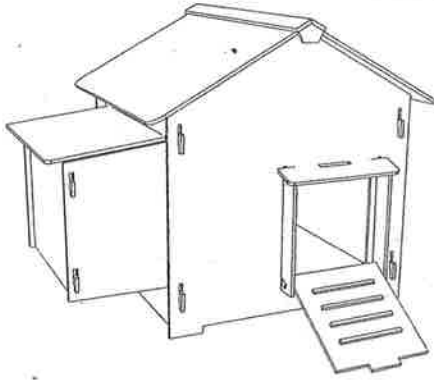
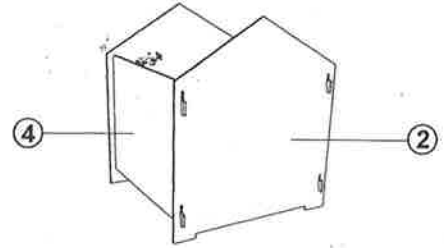

Step 2

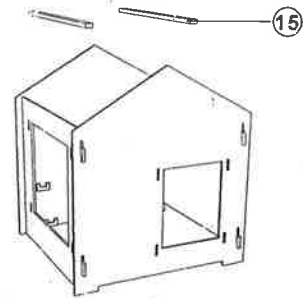

Step 3

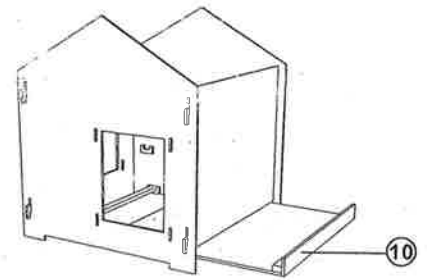

Step 4

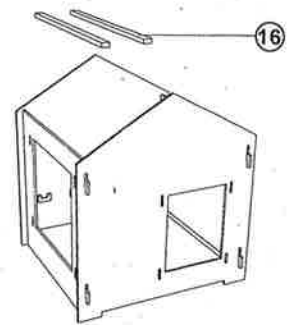

Step 5

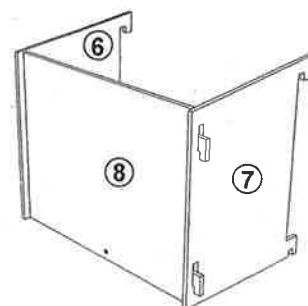

1		1stück
2		1stück
3		1stück
4		1stück
5		1stück
6	1stück 7	1stück
8		1stück
9		1stück
10		1stück
11		1stück
12		1stück
13		2stück
14		1stück
15	2stück 16	2stück
17		2stück

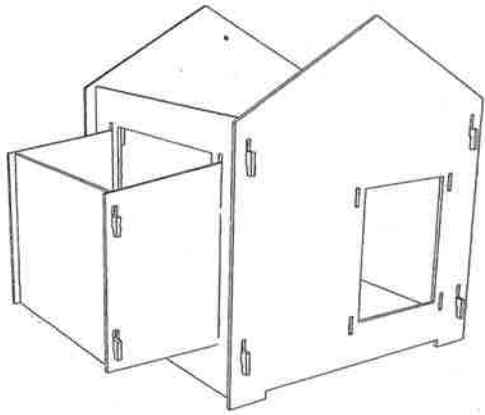

Step 7

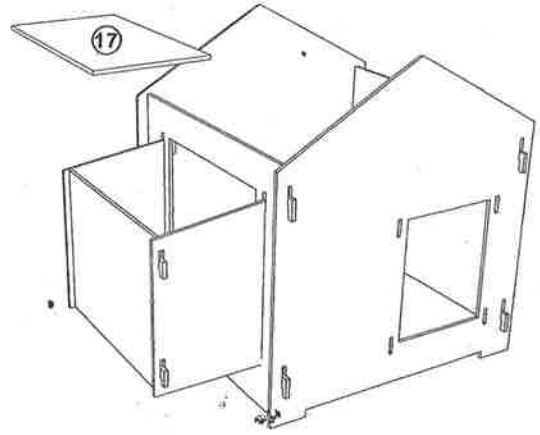

Step 8

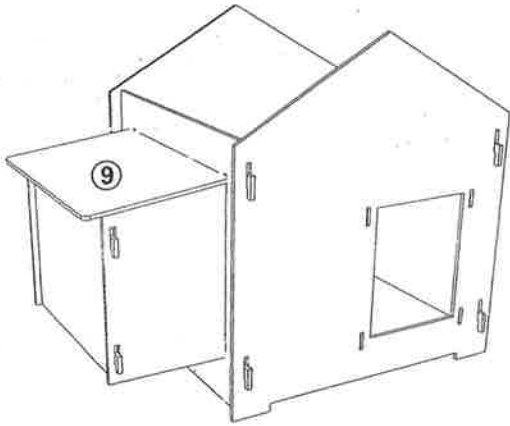

Step 9

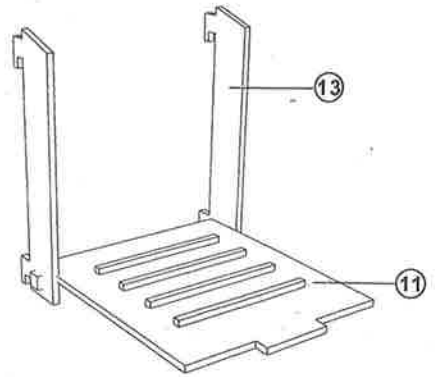

Step 10

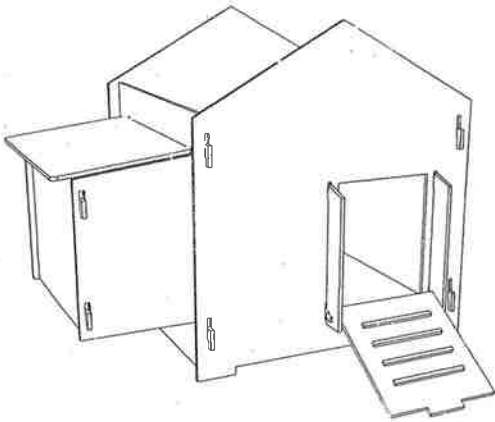

Step 11

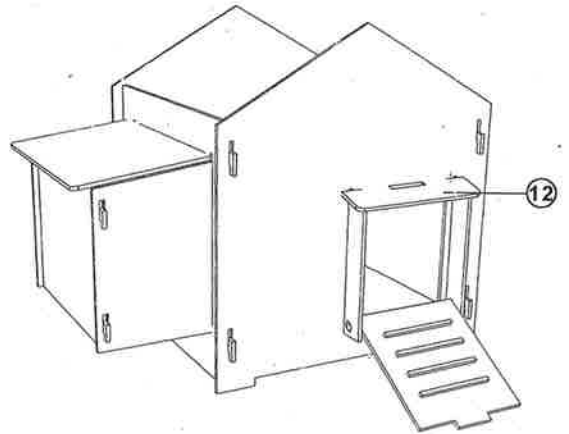

Step 12

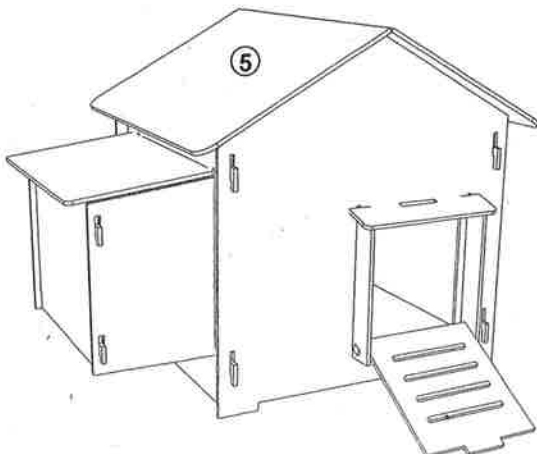

Step 13

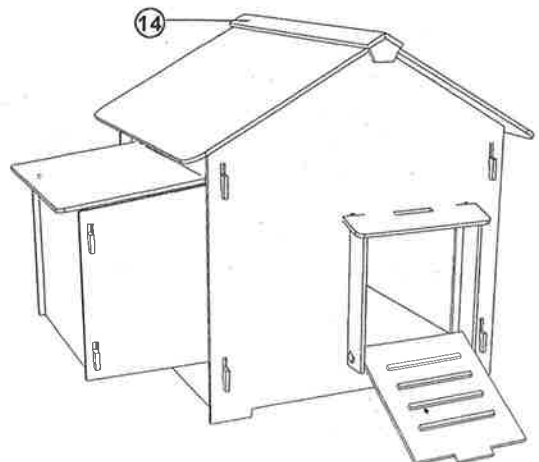

Step 14