

AUFBAUANLEITUNG Gerätehaus „Europa“

- Ⓜ GB Assembly manual for garden shed “Europa“
- Ⓜ FR Notice de montage pour l’abri de jardin “Europa“
- Ⓜ NL Opbouwbeschrijving berging “Europa“
- Ⓜ ES Instrucciones de montaje de la caseta “Europa“
- Ⓜ IT Istruzioni di montaggio Casetta portattrezzi “Europa“
- Ⓜ DK Monteringsvejledning for redskabsskuret “Europa“
- Ⓜ SE Monteringsanvisning för Europa redskapsbod
- Ⓜ NO Monteringsanvisning for boden “Europa“
- Ⓜ PL Instrukcja montażu domku ogrodowego „Europa“
- Ⓜ SK Montážny návod pre záhradný domček „Europa“
- Ⓜ SI Priročnik za montažo vrtno lope „Europa“
- Ⓜ CZ Montážní návod pro zahradní domek „Europa“
- Ⓜ HU Felépítési útmutató „Europa“ szerszámós házhoz
- Ⓜ HR Priručnik za montažu vrtno kuće „Europa“



WICHTIGE PUNKTE FÜR DEN AUFBAU!



VORLIEGENDE AUFBAUANLEITUNG ZEIGT DEN ZUSAMMENBAU VON GERÄTEHAUS „EUROPA“ GRÖSSE „3“; SIE GILT SINNGEMÄSS AUCH FÜR ALLE ANDEREN GRÖSSEN. FÜR EINIGE MONTAGESCHRITTE BENÖTIGEN SIE 1 BIS 2 HELFER.

- GB** Important details regarding assembly! This assembly manual shows the erection of the garden shed model "Europa" size "3"; in the general sense it is valid for all sizes. For several assembly steps additional assistance of 1 or 2 persons will be required.
- FR** Points importants lors du montage! Cette notice de montage décrit l'assemblage de l'abri "Europa" taille « 3 »; celle-ci est valable pour toutes les tailles. Pour certaines étapes, demandez l'aide d'une ou deux personnes.
- NL** Belangrijke punten voor de montage! Deze montage instructies hebben betrekking op de opbouw van de "Europa", grootte 3. De instructies zijn van toepassing op alle maten. Voor enkele montage stappen heeft u 1 of 2 extra mensen nodig.
- ES** Notas importantes para el montaje! Estas instrucciones muestran el montaje de la caseta "Europa" en tamaño 3; Son válidas para todos los tamaños. Es recomendable realizar el montaje entre dos o tres personas.
- IT** Indicazioni importanti per il montaggio! Le seguenti istruzioni di montaggio fanno riferimento all'assemblaggio di "Europa" misura "3"; in senso generale è valido per tutte le misure. Per alcune fasi di assemblaggio vi serviranno 1 - 2 aiutanti.
- DK** Vigtige punkter ved samling! Samlemanualen viser opsætningen af havekur modellen "Europa" str. "3"; fremgangsmåde er også tilsvarende for øvrige størrelser. Ved flere punkter af opsætningen er yderligere hjælp påkrævet af 1 eller 2 personer.
- SE** Dessa monteringsanvisningar visar hur Europa storlek „3“ monteras. Anvisningarna gäller på motsvarande sätt för storlek 1, 2, 2A, 4, 4A, 5, 6, och 7. För vissa monteringssteg behöver du 1 till 2 medhjälpare.
- NO** Denne monteringsanvisningen viser montering av boden "Europa" størrelse "3"; den er også gyldig for størrelse "1", "2", "2A", "4", "4A", "5", "6" og "7" For flere monteringsstrinn vil det være nødvendig med ytterligere assistanse fra 1 eller 2 personer.
- PL** Niniejsza instrukcja wskazuje sposób montażu domku Europa wielkość 3. Pozostałe wielkości - 1, 2, 2A, 4, 4a, 5, 6 i 7 - analogicznie. Może być konieczna pomoc drugiej osoby.
- SK** Táto montážna príručka popisuje stavbu záhradného domčeka „Europa“ veľkosti „3“; platí aj pre veľkosti „1“, „2“, „2A“, „4“, „4A“, „5“, „6“ a „7“. Pri niekoľkých montážnych krokoch bude potrebné ďalšie pomoc 1 alebo 2 osôb.
- SI** Ta priročnik za montažo prikazuje postavitev vrtne lope model "Europa" velikosti "3"; velja tudi za velikosti "1", "2", "2A", "4", "4A", "5", "6" in "7". Za več korakov sestavljanja bo potrebna dodatna pomoč 1 ali 2 oseb.
- CZ** Tato montážní příručka popisuje stavbu zahradního domku „Europa“ velikosti „3“; platí také pro velikost „1“, „2“, „2A“, „4“, „4A“, „5“, „6“ a „7“. U několika montážních kroků bude zapotřebí další pomoc 1 nebo 2 osob.
- HU** Ez a szerelési útmutató a "Europa" 3 méretű ház összeszerelését mutatja; ez értelemszerűen a „1, 2, 2A, 4, 4a, 5, 6, 7“ méretekre is vonatkozik. Néhány összeszerelési lépéshez 1-2 fő segítségére lesz szüksége.
- HR** Ovaj priručnik za montažu prikazuje postavljanje vrtne kuće modela „Europa“ veličine „3“; vrijedi i za veličine „1“, „2“, „2A“, „4“, „4A“, „5“, „6“ i „7“. Za nekoliko koraka montaže bit će potrebna dodatna pomoć 1 ili 2 osobe.

VERWENDEN SIE BEI DER MONTAGE ARBEITSHANDSCHUHE! UM KRATZER ZU VERMEIDEN, VERWENDEN SIE BITTE GEEIGNETE UNTERLAGEN!

- GB** Wear working gloves! Please use a suitable underlay to avoid scratches!
- FR** Portez des gants de travail! Pour éviter les rayures, utilisez les supports appropriés!
- NL** Handschoenen gebruiken! Om krassen te voorkomen raden wij u aan er iets onder te leggen!
- ES** Utilice unos guantes de trabajo. Por favor, coloque en el suelo una base protectora adecuada para evitar posibles arañazos.
- IT** Utilizzare guanti da lavoro. Utilizzare una base adatta per evitare graffi!
- DK** Brug arbejdshandsker! Benyt venligst et passende underlag for at undgå skrammer!
- SE** Använd arbetshandskar under monteringen! Använd lämpliga underlag för att undvika repor!
- NO** Bruk arbeidshansker! Bruk et passende underlag for å unngå riper!
- PL** Podczas montażu proszę używać rękawice ochronne. Chronić powierzchnię lakierowaną przed zarysowaniami.
- SK** Používajte pracovné rukavice! Prosím, použite vhodnú podložku, aby ste zabránili poškrábaniu!
- SI** Uporabite delovne rokavice! Uporabite ustrezno podlago, da se izognete praskam!
- CZ** Při montáži použijte pracovní rukavice! Použijte vhodné podložky, abyste se vyhnuli poškrábání!
- HU** Szerelésnél használjon védőkesztyűt! A karcolások elkerülése érdekében használjon megfelelő alátétetket!
- HR** Nosite radne rukavice! Upotrijebite odgovarajuće podlago, da se izognete praskam!



ACHTEN SIE AUF EINE STURMSICHERE BODENVERANKERUNG UND VERRIEGELN SIE DIE TÜREN! NICHT BEI WIND AUFBAUEN!

- (GB)** Please make sure the product is anchored in a storm-proof manner and lock the doors/lid! Do not assembly in windy condition!
- (FR)** Veillez à ce que le sol soit ancré de manière à résister aux tempêtes et verrouillez les portes/couvercles ! Ne pas procéder au montage dans des conditions venteuses !
- (NL)** Zorg voor een stormbestendige bodem verankering en vergrendel de deuren/deksel! Niet opbouwen in winderige omstandigheden!
- (ES)** Asegúrese de que el suelo cuente con un anclaje a prueba de tormentas y cierre las puertas/tapas. ¡No se instalen en condiciones de viento!
- (IT)** Assicuratevi che il pavimento sia ancorato a prova di tempesta e chiudete a chiave le porte/coperchio! Non montare in condizioni di vento!
- (DK)** Vær opmærksom på at produktet forankres stormsikkert samt at dør/låg er aflåst! Bør ikke monteres ved kraftig vind!
- (SE)** Se till att markförankringen är stormsäker och lås dörrar! Genomför inte monteringen när det blåser!
- (NO)** Forsikre deg om at produktet er ordentlig forankret på en storm sikker måte og lås dørene / lokket! Ikke monter når det blåser mye!
- (PL)** Zwróć uwagę na wiatroodporne zakotwiczenie w ziemi i zamykaj drzwi/pokrywy! Nie montować przy silnym wietrze!
- (SK)** Dbajte na podlahové ukotvenie proti víchrici a zaistite dvere/ poklop! Nerobte montáž pri vetre!
- (SI)** Prepričajte se, da je izdelek zasidran zaradi neviht in zaklepajte vrata / pokrov! Ne sestavljajte v vetrovnem stanju!
- (CZ)** Zkontrolujte podlahové ukotvení odolné proti bouři a zamkněte dveře/víka! Nenechávejte ve větru otevřené a nezajištěné!
- (HU)** Figyeljen a padló viharbiztos rögzítésére, valamint az ajtó és a tető zárhatóságára! Ne szélben építse fel!
- (HR)** Molimo osigurajte da je proizvod usidren na oluju i zaključajte vrata / poklopac! Ne montirajte u vjetrovitom stanju!



ACHTUNG: IM SOMMER KÖNNEN IM INNENRAUM SEHR HOHE TEMPERATUREN ENTSTEHEN!

- (GB)** Attention: during the summer high temperature might arise in the interior.
- (FR)** Attention: En été la température à l'intérieur de l'abri peut être élevée!
- (NL)** Let op: in de zomer kunnen in de berging zeer hoge temperaturen bereikt worden.
- (ES)** Tenga en cuenta que en el verano las temperaturas en el interior pueden ser altas.
- (IT)** I dadi devono essere serrati a fondo soltanto alla fine del montaggio!
- (DK)** Attention: Si prega di prendere nota che in estate si possono essere temperature molto elevate all'interno.
- (SE)** På sommaren kan mycket höga temperaturer uppstå inne i redskapsboden!
- (NO)** OBS: om sommeren kan det oppstå høy temperatur inne i produktet.
- (PL)** Uwaga: latem temperatura wewnątrz może wysoko wzrosnąć!
- (SK)** Pozor: v lete môže v interiéri dôjsť k zvýšeniu teploty.
- (SI)** Pozor: poleti se lahko v notranjosti pojavi visoka temperatura.
- (CZ)** Pozor: v létě může v interiéru dojít ke zvýšení teploty.
- (HU)** FIGYELEM: Nyáron a tárolók belsejében nagyon magas lehet a hőmérséklet!
- (HR)** Pažnja: tijekom ljeta u unutrašnjosti se može pojaviti visoka temperatura.



SCHRAUBVERBINDUNGEN GRUNDSÄTZLICH ERST AM ENDE DER MONTAGE FESTZIEHEN!

- (GB)** Nuts not to be tightened before the end of assembly!
- (FR)** Ne serrer les écrous à fond qu'à la fin du montage!
- (NL)** Schroeven pas aan het einde van de montage vastdraaien!
- (ES)** En principio, no apriete fijamente las tuercas hasta que no haya terminado de montar la caseta.
- (IT)** I dadi devono essere serrati a fondo soltanto alla fine del montaggio!
- (DK)** Møtrikkerne må ikke strammes før slutningen af opsætningen!
- (SE)** Dra alltid åt skruvförbanden först i slutet av monteringen!
- (NO)** Muttere som ikke skal strammes til før monteringen er ferdig!
- (PL)** Śruby dokręcić ostatecznie dopiero po zakończeniu montażu.
- (SK)** Matica dotahujte až pred koncom montáže!
- (SI)** Matic ne privijte pred koncem montaže!
- (CZ)** Matice dotahujte až před koncem montáže!
- (HU)** A csavarokat mindig csak az összeszerelés végén kell erősen meghúzni!
- (HR)** Matice ne treba stezati prije kraja montaže!

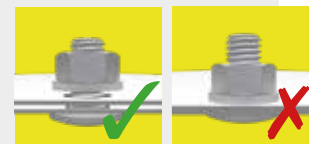

OPTIONALES ZUBEHÖR - SYMBOL:

Arbeitsschritte die blau eingerahmt sind, zeigen den Einbau eines optionalen Zubehörteiles.

- (GB)** Symbol of optional accessories: Blue framed assembly steps show the installation of optional accessories.
- (FR)** Accessoires en option-Symbole: La trame entourée en bleu indique une étape avec accessoires en option. A réaliser uniquement si vous avez commandé cet accessoire.
- (NL)** Extra Toebehoor: Montagestappen met een blauwe rand betreffen de inbouw van extra toebehoor.
- (ES)** Accesorio opcional – símbolo: Los pasos de montaje que se encuentran enmarcados en azul muestran el montaje de una pieza de un accesorio opcional.
- (IT)** Simbolo per accessori opzionali: Le fasi del montaggio incorniciate in colore azzurro mostrano l'installazione di un accessorio opzionale.
- (DK)** Symbol for ekstra udstyr: Blåt indrammet samletrin viser installationen af ekstraudstyr
- (SE)** Symbol för extra tillbehör: Arbetssteg som är inramade i blått visar hur ett valfritt tillbehör installeras.
- (NO)** Symbol for tilleggsutstyr: Blå innrammede monteringsstrinn viser installasjonen av ekstrautstyr.
- (PL)** Wyposażenie dodatkowe - symbol: Czynności w niebieskiej ramce dotyczą elementów wyposażenia dodatkowego.
- (SK)** Symbol voliteľného príslušenstva: Montážne kroky v modrom rámečku ukazujú inštaláciu voliteľného príslušenstva.
- (SI)** Simbol dodatne opreme: Montažni koraki v modrem okvirju prikazujejo namestitve dodatne opreme.
- (CZ)** Symbol volitelného příslušenství: Montážní kroky v modrém rámečku ukazují instalaci volitelného příslušenství.
- (HU)** Opcionális tartozék – szimbólum: A kékkel bekeretezett munkafolyamatok az opcionális tartozék beépítését jelölik.
- (HR)** Simbol dodatne opreme: Montažni koraci u plavom okviru ukazuju na ugradnju dodatne opreme.



MASSTABSGETREUE ABBILDUNGEN DER ZU VERWENDENDEN SCHRAUBEN: (M 1:1)

- (GB)** Scale drawing 1:1 of the screws in use
- (FR)** Reproduction selon l'échelle 1:1.
- (NL)** Afbeelding : schaal 1:1 (ware grootte)
- (ES)** Reproducción a escala 1:1 de los tornillos que se utilizan para el montaje.
- (IT)** Immagine in scala delle viti da utilizzare!
- (DK)** Skala tegning af skruer er 1:1
- (SE)** Skalenliga ritningar av skruvarna som ska användas:
- (NO)** Måltegning 1: 1 av skruene som er i bruk
- (PL)** Skalowane ilustracje używanych śrub:
- (SK)** Mierka výkresu 1: 1 použitých skrutiek
- (SI)** Risba v merilu 1: 1 uporabljenih vijakov
- (CZ)** Měřitko výkresu 1: 1 použitých šroubů
- (HU)** A felhasználandó csavarok méretarányos ábrái:
- (HR)** Crtež veličine 1: 1 vijaka koji se koriste

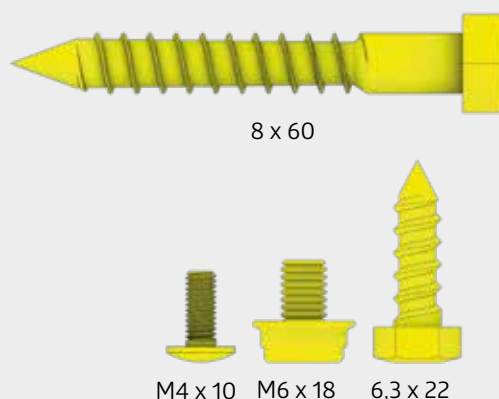

WASSERWAAGEN - SYMBOL:

Betreffendes Einbauteil mit der Wasserwaage ausrichten.

- (GB)** Symbol of spirit level: Align the respective parts by using the spirit level.
- (FR)** Symbole niveau à bulle: Lorsque ce symbole apparaît, vous devez ajuster l'élément à l'aide d'un niveau à bulle.
- (NL)** Waterpas – symbol: Bij montagestappen waar dit symbool bijstaat is het noodzakelijk het betreffende onderdeel waterpas in te bouwen.
- (ES)** Símbolo del nivelador: Indica que se debe ajustar y centrar la pieza con la ayuda de un nivelador.
- (IT)** Simbolo di livella a bolla d'aria: Allineare il componente in questione con l'ausilio di una livella a bolla d'aria.
- (DK)** Symbol for vaterpas: Juster de respektive dele ved hjælp af vaterpas.
- (SE)** Vattenpassymbol: Rikta in relevant installationsdel med vattenpasset.
- (NO)** Symbol på vater: Juster de respektive delene ved å bruke et vater.
- (PL)** Symbol poziomicy - element wypoziomować.
- (SK)** Symbol vodováhy: Vyrovnajte príslušnej časti pomocou vodováhy.
- (SI)** Simbol vodne tehtnice: Poravnajte ustrezne dele z uporabo vodne tehtnice.
- (CZ)** Symbol vodováhy: Vyrovnajte příslušné části pomocí vodováhy.
- (HU)** Vízmérték – szimbólum: A szükséges elem beállításához használjon vízmértéket.
- (HR)** Simbol libele: Poravnajte odgovarajuće dijelove pomoću libele.

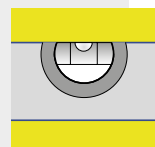

GRÖSSENABHÄNGIGER MONTAGESCHRITT!

- (GB)** Size-Dependent assembly step!
- (FR)** L'étape d'assemblage dépend de la taille de l'abri!
- (NL)** Montage stap afhankelijk van de grootte!
- (ES)** Paso de montaje dependiente del tamaño de la caseta!
- (IT)** Misura-dipendente fase di montaggio!
- (DK)** Størrelses-afhængig montage skridt
- (SE)** Storleksberoende monteringssteg!
- (NO)** Størrelsesavhengig monteringsstrinn!
- (PL)** Sposób montażu zależny od wielkości.
- (SK)** Montážny krok závislý od veľkosti!
- (SI)** Korak montaže odvisen od velikosti!
- (CZ)** Montážní krok závislý na velikosti!
- (HU)** Mérettől függő összeszerelési lépés!
- (HR)** Korak sklopa ovisno o veličini!



NAGEL - SYMBOL:

Bitte verwenden Sie den beiliegenden Nagel, um die Löcher der einzelnen Bleche auszurichten.

- (GB)** Symbol of nail: Please use the attached nail to align the holes of each sheet.
- (FR)** Symbole clou : veuillez utiliser le clou fourni pour aligner les trous sur chaque paroi.
- (NL)** Spijker-symbol: Bij montageschappen waar dit symbool bijstaat dient de spijker voor het laten corresponderen van 2 schroefgaten.
- (ES)** Símbolo del clavo: Utilice los clavos suministrados para alinear los orificios de cada chapa.
- (IT)** Simbolo del chiodo: Si prega di utilizzare il chiodo incluso per allineare i buchi di ogni lamiera.
- (DK)** Søm-symbol: Brug de medfølgende søm til at rette hullerne på de enkelte plader ind
- (SE)** Spiksymbol: Använd den medföljande spiken för att rikta in hålen i de enskilda plåtarna.
- (NO)** Symbol på spiker: Bruk den påsatte spikeren til å rette hullene på hvert plate.
- (PL)** Gwóźdź: Proszę użyć dołączonego gwoździa, aby wyrównać otwory poszczególnych arkuszy
- (SK)** Symbol klinca: Prosím, použite priložený klinec na vyrovnání otvorů všech plechů.
- (SI)** Simbol žablja: s pritrjenim žabljem poravnajte luknje na vsakem listu.
- (CZ)** Symbol hřebíku: Prosím, použijte přiložený hřebík k vyrovnání otvorů všech plechů.
- (HU)** Szeg-szimbólu: Kérem, használja a mellékelt szöveget az egyes lemezek lyukainak kiigazításához
- (HR)** Simbol čavla: Pomoću priloženog čavla poravnajte rupe na svakom listu.



PFLEGE UND WARTUNG

Keine aggressiven Chemikalien wie z.B. Chlor oder Streusalz lagern!

Sonnenmilch und andere Cremes mit Wasser und Seife entfernen.

Keine scheuernden Reinigungsmittel verwenden!

Laub vom Dach regelmäßig entfernen! Dachgully kontrollieren!

Tiefe Kratzer sofort mit beiliegendem Lack ausbessern!

Ölen Sie das Schloss jährlich!

Schraubverbindungen regelmäßig kontrollieren!

- GB** Care and maintenance: Do not store aggressive substances i.e. chlorine or road salt! Remove suntan lotion or any other creams with soap and water! Do not use abrasive cleaning agents! Keep the roof free of leaves! Check roof gully! ! Touch-up scratches immediately with the paint provided. Lubricate the lock once a year! Check screw connections regularly!
- FR** Entretien et maintenance: Ne pas stocker de produits chimiques (chlore, sel, etc...) ! Nettoyez uniquement avec de l'eau les crèmes solaires et autres crèmes (pas de nettoyant chimique). Ne pas utiliser de produits nettoyant abrasifs! Débarrassez vous régulièrement des feuilles mortes sur le toit! Vérifiez la gouttière du toit ! Corrigez immédiatement les rayures avec la laque jointe! Graissez la serrure et les charnières chaque année! Vérifiez régulièrement les raccords à vis!
- NL** Onderhoud: Geen chemicaliën in de berging opslaan! Zonnebrandolie/melk en andere cremes met water en glansmiddel verwijderen. Gebruik geen schuurmiddelen! Regelmatig bladeren van dak verwijderen! Controleer de dakgoot! - Krassen direct met de meegeleverde lak behandelen. Slot jaarlijks oliën. Controleer regelmatig de schroefverbindingen!
- ES** Cuidado y mantenimiento: No almacene productos químicos agresivos dentro de la caseta como por ejemplo cloro y sal antiestarcacha. Evite dejar huellas o restos de cremas solares sobre la chapa. Limpie la caseta siempre con agua y jabón. No utilice ningún producto para fregar. En general, evite siempre cualquier producto químico para limpiar la caseta. Mantenga el tejado libre de hojas secas. Compruebe el desajuste del tejado. Repare los arañazos lo antes posible con el barniz que se incluye. Aplique aceite en la cerradura y las bisagras una vez al año. ¡Compruebe las conexiones de los tornillos regularmente!
- IT** Manutenzione: Non lasciare prodotti chimici aggressivi (come ad esempio cloro o sale per strade) all'interno della casetta! Rimuovere crema solare e altre creme con acqua e brillantante! Non utilizzare detergenti contenenti sostanze aggressive! Mantenere il tetto libero da foglie! Controllare la grondaia! Ritoccare immediatamente eventuali graffi con la vernice fornita nella confezione! Lubrificare la serratura e le cerniere a cadenza annuale! Controllare regolarmente i collegamenti a vite!
- DK** Pleje og vedligeholdelse: Opbevar ikke aggressive stoffer dvs. Klor eller vejsalt! Fjern solcreme eller andre typer af creme med vand og rensningsmiddel! Brug ikke aggressive rengøringsmidler! Hold taget fri for blade! Kontrollér tag afløb! ! Ved skrammer, brug straks malingen som er stillet til rådighed! Smør låsen årligt! Kontrollér skruesamlinger jævnligt!
- SE** Skötsel och underhåll: Förvara inga aggressiva kemikalier som klor eller vägsalt öppet! Ta bort solkräm och andra krämer med tvål och vatten. Använd inte slipande rengöringsmedel! Ta bort löv från taget regelbundet! Kontrollera takavloppet! Kontrollera avloppsrännan! Reparera omedelbart djupa repor med medföljande färg! Olja låset årligen! Kontrollera skruvanslutningarna regelbundet!
- NO** Stell og vedlikehold: ikke oppbevar aggressive stoffer, dvs. klor eller veisalt! Fjern solkrem eller andre kremer med vann og skyllemiddel! Ikke bruk slipende rengjøringsmidler! Hold taket fritt for blade! Sjekk takrenna! Lakk over riper umiddelbart med medfølgende lakkstift. Smør låsen en gang i året! Kontrollér skruerforbindelsene regelmessig!
- PL** Pielęgnacja i konserwacja: Nie przechowywać chemikaliów jak związki chloru lub sól drogowa. Ewentualne zabrudzenia usuwać mydłem i wodą. Nie używaj ściernych środków czyszczących! Regularnie usuwaj liście z dachu! Sprawdź wylot rynny! Natychmiast napraw głębokie zadrapania za pomocą dołączonej farby! Co roku smaruj zamek!
- SK** Starostlivosť a údržba: Neskladujte agresívne látky, napr. chlór alebo posypovú soľ! Opaľovací krém alebo iné krémy odstráňte vodou a leštidlom! Nepoužívajte abrazívne čistiace prostriedky! Udržujte strechu bez listia! Skontrolujte odkvapové žľaby! Škrabance okamžite opravte priloženým opravným lakom. Raz ročne premažte zámky! Pravidelne kontrolujte skrutkové spoje!
- SI** Nega in vzdrževanje: Ne shranjujte agresivnih snovi, npr. Klor ali cestne soli! Losjon za sončenje ali druge kreme odstranite z vodo in sredstvom za izpiranje! Ne uporabljajte abrazivnih čistil! Na strehi naj ne bo listja! Preverite žleb! Prask se takoj dotaknite s priloženo barvo. Ključavnico namažite enkrat letno! Redno preverjajte vijakne povezave!
- CZ** Péče a údržba: Neskladujte agresivní látky, např. chlor nebo posypovou sůl! Opaľovací krém nebo jiné krémy odstráňte vodou a leštídem! Nepoužívejte abrazivní čisticí prostředky! Udržujte střechu bez listí! Zkontrolujte okapové žľaby! Škrábane okamžitě opravte příloženým opravným lakem. Jednou ročně promažte zámky! Pravidelně kontrolujte šroubové spoje!
- HU** Ápolás és karbantartás: Ne tároljon semmiféle agresszív vegyszert, mint pl.: klórt vagy sót bontatlan állapotban! Távolítsa el a naptej és az egyéb krémeket víz és szappan használatával. Ne használjon súrolószereket! Rendszeresen távolítsa el a leveleket a tetőről! Ellenőrizze a tetőn lévő esővízelvezetőt! A mellékelt lakkal javítsa ki rőgtön a mély karcolásokat! Évente olajozza be a zárat! Rendszeresen ellenőrizze a csavarokat!
- HR** Njega i održavanje: Ne skladištite agresivne tvari, tj. Klor ili cestovnu sol! Losion za sunčanje ili bilo koje druge kreme uklonite vodom i sredstvom za ispiranje! Ne koristite abrazivna sredstva za čišćenje! Krov ne ostavljajte bez lišća! Provjerite oluk! Odmah dodirnite ogrebotine s priloženom bojom. Podmažite bravu jednom godišnje! Redovito provjeravajte vijčane spojeve!

UMGANG MIT BESCHÄDIGTEN TEILEN

Verbauen Sie keine beschädigten Teile! Falls Sie Beschädigungen feststellen, müssen diese vorab inkl. aussagekräftiger Bilder an uns gemeldet werden. Durch den Verbau gelten die Teile als akzeptiert.

- (GB)** Handling of damaged parts: Do not install damaged parts! If you note damages, they must be reported to us in advance, including meaningful pictures. The parts are considered accepted by the installation.
- (FR)** Manipulation des pièces endommagées: N'installez pas de pièces endommagées ! Si vous découvrez des dommages, vous devez nous en informer à l'avance, en nous envoyant des photos significatives. Après le montage, les pièces sont considérées comme acceptées.
- (NL)** Omgaan met beschadigde onderdelen: Monteer géén beschadigde onderdelen! Als u schade ontdekt, moet dit vooraf aan ons worden gemeld, inclusief duidelijke foto's. Als u de beschadigde onderdelen toch monteert, dan heeft u hiermee het product "geaccepteerd".
- (ES)** Manejo de partes dañadas: Por favor, NO instale partes dañadas, Si descubre algún daño, debe informarnos con antelación, incluyendo fotos claras de los daños. Las piezas se consideran aceptadas si se realiza su la instalación.
- (IT)** Gestione di parti danneggiate: Non installare parti danneggiate! Se si rivela un danno, questo deve essere segnalato in anticipo per mail con materiale fotografico a supporto del reclamo. Se si procede all'installazione delle parti danneggiate, Biohort si riserva il diritto di respingere il reclamo.
- (DK)** Håndtering af beskadigede dele: Brug ikke beskadigede dele! Hvis du opdager nogen skade, skal dette rapporteres til os på forhånd, herunder meningsfulde billeder. Dele betragtes som accepteret gennem installationen.
- (SE)** Hantering av skadade delar: Använd inte skadade delar! Om du upptäcker några skador måste detta rapporteras till oss i förväg, inklusive meningsfulla bilder. Delarna anses accepterade när de installeras.
- (NO)** Håndtering av ødelagte deler: Ikke monter ødelagte deler! Hvis du registrerer skader, må du rapportere dette til oss, og sende bilder av de skadde delene. Hvis skadde deler blir montert, anses de som akseptert av montøren.
- (PL)** POSTĘPOWANIE Z USZKODZONYMI CZĘŚCIAMI Nie używaj uszkodzonych części! W przypadku stwierdzenia jakichkolwiek uszkodzeń należy je zgłosić wraz ze szczegółowymi zdjęciami. Elementy uszkodzone zainstalowane uważane są za zaakceptowane.
- (SK)** Zaobchádzanie s poškodenými dielmi: V prípade že zistíte nejaké poškodenia, musia nám byť tieto nahlásené aj s príslušnými fotografiami. V prípade zabudovania budú diely považované za akceptované.
- (SI)** Ravnanje s poškodovanimi deli: Poškodovanih delov ne nameščajte! Če opazite škodo, nam je to treba sporočiti vnaprej, vključno s slikami. Namestitvev šteje, kot da so deli sprejeti.
- (CZ)** Manipulace s poškozenými částmi: Pokud zjistíte poškození, musíte nám to nahlásit předem, včetně průkazných obrázků. Díly jsou považovány za přijaté jejich instalací.
- (HU)** A sérült alkatrészek kezelése: Ha bármilyen sérülést észlel, a sérült elemeket képekel igazolva jeleni kell felénk. A beépítéssel, az elemeket elfogadottnak tekintjük.
- (HR)** Rukovanje oštećenim dijelovima: Nemojte postavljati oštećene dijelove! Ako primijetite štetu, morate nam je prijaviti unaprijed, uključujući značajne slike. Instalacija smatra da su dijelovi prihvaćeni.

HALTEN SIE WÄHREND DES ZUSAMMENBAUS ALLE MITGELIEFERTEN KLEINTEILE ODER VERPACKUNGSMATERIALIEN FERN VON KLEINKINDERN.

Bauteile weisen scharfe Kanten auf oder stehen vor, achten Sie während der Montage und bei der täglichen Nutzung darauf.

- (GB)** Keep all supplied small parts or packaging materials away from small children during assembly. Components have sharp edges or protrude, pay attention to them during assembly and during daily use.
- (FR)** Gardez toutes les petites pièces ou les matériaux d'emballage fournis hors de portée des enfants pendant le montage. Les pièces d'assemblage peuvent être tranchantes, faites-y attention lors de l'assemblage et de l'utilisation quotidienne.
- (NL)** Houd alle kleine onderdelen of verpakkingsmaterialen die worden mee geleverd uit de buurt van kleine kinderen tijdens de montage. Onderdelen hebben scherpe randen of steken uit, let op bij de montage en bij het dagelijks gebruik.
- (ES)** Mantenga todas las piezas pequeñas o materiales de embalaje suministrados lejos de los niños durante el montaje. Los componentes tienen bordes afilados o salientes, preste atención a ellos durante el montaje y durante el uso diario.
- (IT)** Tenere tutte le piccole parti o i materiali d'imballaggio forniti lontano dalla portata dei bambini durante il montaggio. I componenti hanno spigoli vivi o sporgenti, prestare attenzione ad essi durante il montaggio e durante l'uso quotidiano.
- (DK)** Hold alle leverede smådele og emballage utilgængeligt for børn under montagen. Komponenter har skarpe kanter eller stikker ud, vær opmærksom på dem under monteringen og under daglig brug.
- (SE)** Håll alla medföljande smådelar och förpackningsmaterial borta från småbarn under monteringen. Komponenterna kan ha vassa kanter eller utstickande delar, var uppmärksam på detta vid monteringen och daglig användning.
- (NO)** OBS: Hold alle smådeler og emballagematerialer borte fra små barn under monteringen. Komponentene har skarpe kanter eller noe som stikker ut, vær oppmerksom på dette under monteringen og under den daglige bruken.
- (PL)** ZACHOWAJ WSZYSTKIE MAŁE CZĘŚCI PODCZAS MONTAŻU LUB MATERIAŁY OPAKOWANIA Z DALA OD MAŁYCH DZIECI. Elementy mają ostre lub wystające krawędzie, należy zwracać na to uwagę podczas montażu i codziennego użytkowania.
- (SK)** Udržujte počas montáže všetky dodané malé diely a obalové materiály mimo dosahu malých detí. Komponenty majú ostré hrany alebo vyčnievajúce časti. Dbajte na to počas montáže a každodenného používania.
- (SI)** POZOR: Med montažo naj bodo vsi dobavljeni majhni deli ali embalažni materiali oddaljeni od majhnih otrok. Sestavni deli imajo ostre robove ali pa štrlijo, bodite pozorni nanje med sestavljanjem in med vsakodnevno uporabo.
- (CZ)** Během montáže udržujte všechny malé dodávané díly nebo obalové materiály mimo dosah malých dětí. Díly mají ostré hrany nebo vyčnívají, věnujte jim pozornost při montáži a každodenním používání, aby nedošlo k úrazu.
- (HU)** Az összeszerelés során kisgyerekektől tartsa távol az apró alkatrészeket valamint a csomagolóanyagokat. A szerelés és a napi használat során ügyeljen az éles szélekre valamint a kiálló részekre.
- (HR)** PAŽNJA: Tijekom montaže držite sve isporučene male dijelove ili materijale za pakiranje podalje od male djece. Sastavni dijelovi imaju oštre rubove ili strše, obratite pažnju na njih tijekom montaže i tijekom svakodnevnog uporabe.

VORSCHLÄGE FÜR DAS FUNDAMENT

Bitte achten Sie bei der Fundamentgestaltung darauf, dass Niederschlagswasser nicht seitlich unter den Bodenprofilen in das Gerätehaus eindringen kann! Aufsteigende Bodenfeuchtigkeit und Kondensation vermeiden Sie mittels einer starken Kunststoffolie unter dem Fundament.

- (GB)** Proposals for a secure foundation: When making the foundation arrangements please take necessary precaution to ensure that water cannot leak in under the floor profiles. Rising ground moisture and condensation can be avoided by using a strong plastic sheet underneath the paving slabs or underneath the concrete foundation.
- (FR)** Conseils pour les fondations: Lors de la réalisation de la fondation, veillez à ce que l'eau de pluie ne puisse pas pénétrer dans l'abri ou par les côtés sous les profils de sol. Vous pouvez éviter l'humidité du sol et la condensation en mettant un film plastique épais sous les plaques de béton.
- (NL)** Voorstellen voor fundament : Let er bij het maken van de fundering op dat regenwater niet onder het bodemprofiel kan doorlopen. Een vochtige bodem en condensatie kunt u vermijden door het aanbrengen van een sterke kunststoffolie onder de tegels of het betonfundament.
- (ES)** Medidas y recomendaciones para los cimientos: Al colocar los cimientos, asegúrese de que el agua de lluvia no puede penetrar en la caseta por los laterales debajo del perfil del suelo. Evite la humedad y la condensación en el suelo colocando una lámina de plástico bajo las losas o los cimientos de hormigón.
- (IT)** Proposte per il basamento: Il basamento deve essere progettato in modo da evitare infiltrazioni di acqua piovana all'interno della casetta. Un telo di plastica spesso posto in corrispondenza dell'area di pavimento evita infiltrazioni di umidità dal terreno e la formazione di condensa.
- (DK)** Forslag til sikkert fundament: Ved etablering af fundament skal du tage de nødvendige forholdsregler for at sikre, at vand ikke kan sive ind under gulvprofilerne. Stigende fugt og kondens i jorden kan undgås ved at bruge plastik under flisebelægningen eller under betonfundamentet.
- (SE)** Förslag för fundamentet: Se till att regnvatten inte kan tränga in i redskapsboden från sidan under golvprofilerna när du utformar fundamentet! Du kan undvika stigande markfuktighet och kondens genom att placera en kraftig plastfilm under fundamentet.
- (NO)** Forslag til ett sikkert fundament: Når du lager fundamentet, må du ta nødvendige forholdsregler for å sikre at vann ikke kan lekke inn under golvprofilene. Økende fuktighet og kondens på bakken kan unngås ved å bruke en sterk plastduk under belegningsplatene eller under betongfundamentet.
- (PL)** Uwagi dot. Fundamentu: Przy projektowaniu fundamentu należy zwrócić uwagę, aby woda opadowa nie przedostawała się do wnętrza pod profilami podłogowymi! Stosować izolację z folii z tworzywa sztucznego.
- (SK)** Návrhy pre bezpečný základ: Pri príprave základov prosím vykonajte potrebné opatrenia, aby ste zabezpečili, že pod podlahovými profilmi nebude môcť presakovať voda. Stúpajúci zemnej vlhkosti a kondenzácii možno zabrániť použitím silného plastového plechu pod dlažobnými doskami alebo pod betónovým základom.
- (SI)** Predlogi za varne temelje: Pri pripravi temeljev upoštevajte ustrezne previdnostne ukrepe, da zagotovite, da voda ne more uhajati pod talnimi profili. Naraščajoči vlagi in kondenzaciji tal se lahko izognemo z uporabo močne plastične folije pod tlakovci ali pod betonskim temeljem.
- (CZ)** Návrhy pro bezpečný základ: Při přípravě základů prosím proveďte nezbytná opatření, abyste zajistili, že pod podlahovými profily nebude moci prosakovat voda. Stoupající zemní vlhkosti a kondenzaci lze zabránit použitím silného plastového plechu pod dlažebními deskami nebo pod betonovým základem.
- (HU)** Javaslatok az alapzathoz: Az alapzat elhelyezésekor kérem, ügyeljen arra, hogy az esővíz ne juthasson be a padlóprofilok alatt a szerszámtárolóba!! Elkerülheti az emelkedő talajnedvességet és páralecsapódást úgy, hogy egy erős műanyag fóliát helyez az alapzatra.
- (HR)** Prijedlozi za siguran temelj: Prilikom izrade temelja, poduzmite potrebne mjere predostrožnosti kako biste osigurali da voda ne može procuriti ispod podnih profila. Povećana vlaga i kondenzacija u tlu mogu se izbjeći upotrebom jakog plastičnog lima ispod pločica za popločavanje ili ispod betonskog temelja.

FUNDAMENTDETAILS

Weitere Details betreffend Fundament finden Sie auch unter www.biohort.com/Fundament

- (GB)** Further details about foundations you will find at www.biohort.com/foundation
- (FR)** Pour des détails supplémentaires, veuillez consulter www.biohort.com/foundations
- (NL)** Verdere details over het fundament vindt u ook op www.biohort.com/fundament
- (ES)** Encuentre información detallada sobre los cimientos en: www.biohort.com > servicios > cimientos
- (IT)** Per ulteriori dettagli si prega di consultare www.biohort.com/it/servizi/suggerimenti-per-le-fondamenta
- (DK)** Yderligere informationer om fundamentet finder du på www.biohort.com/foundation
- (SE)** Mer information om fundamentet hittar du även på www.biohort.com/se/service/fundamenttips
- (NO)** Ytterligere informasjon om fundament finner du på www.biohort.com/foundation
- (PL)** Więcej informacji n.t. montażu fundamentów na stronie: www.biohort.com/Fundament
- (SK)** Ďalšie informácie o základoch nájdete na www.biohort.com/foundation
- (SI)** Nadaljnje podrobnosti o temeljih najdete na www.biohort.com/foundation
- (CZ)** Další informace o základech najdete na www.biohort.com/foundation
- (HU)** Az alapzathoz szükséges további részletek a www.biohort.com/hu/szerviz/alapzat-oetletek-oldalon-talalhatok.
- (HR)** Dodatne detalje o zakladama naći ćete na www.biohort.com/foundation

SMARTBASE



SMARTBASE^{PLUS}



BETONFUNDAMENT

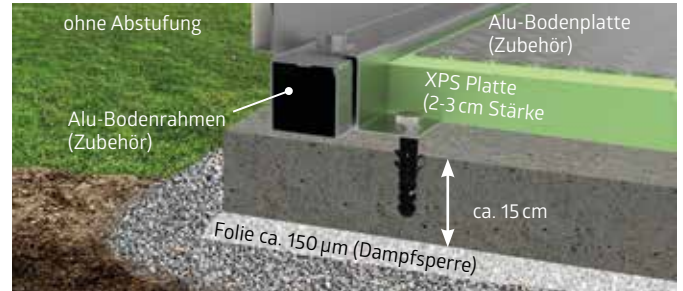

PUNKTFUNDAMENT

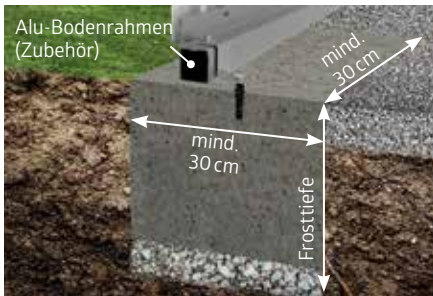

GEHWEGPLATTEN

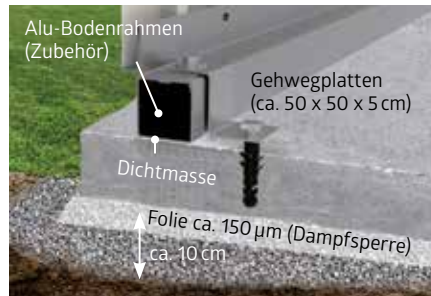

BODENRAHMEN

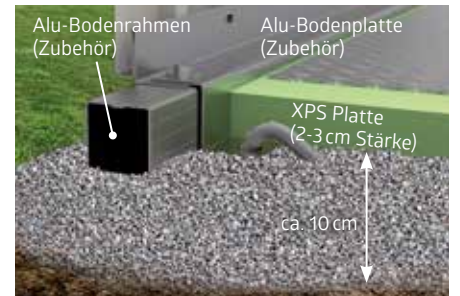

MASSE FÜR DAS FUNDAMENT:

Für die Montage werden mindestens 50 cm Platz rund um das Fundament benötigt!

- (GB)** Foundation dimensions: At least 50 cm space around the foundation is required for installation.
- (FR)** Dimensions pour la fondation: Un espace d'au moins 50 cm autour de la fondation est nécessaire pour le montage.
- (NL)** Maat voor het fundament: Voor de montage is ten minste 50 cm ruimte rond de fundering nodig.
- (ES)** Medidas de los cimientos: Se requiere un espacio de al menos 50 cm alrededor de los cimientos para su instalación.
- (IT)** Dimensioni del basamento: Per l'installazione sono necessari almeno 50 cm di spazio intorno alla fondazione.
- (DK)** Fundament dimensioner: For montage kræves yderligere 50cm plads omkring fundamentet
- (SE)** Fundamentets mått: För montering krävs minst 50 cm utrymme runt fundamentet.
- (NO)** Fundament dimensjoner: Det kreves minst 50 cm plass rundt fundamentet for installasjon.
- (PL)** Wymiary fundamentu: Do instalacji potrzeba około 50 cm przestrzeni wokół fundamentu.
- (SK)** Rozmery základov: Pre inštaláciu je potrebné aspoň 50 cm priestoru okolo základne.
- (SI)** Dimenzije temelja: Za vgradnjo je potreben vsaj 50 cm prostora okoli temeljev.
- (CZ)** Rozměry základů: Pro instalaci je zapotřebí alespoň 50 cm prostoru kolem základny.
- (HU)** Alapzathoz szükséges méretek: A felépítéshez az alapzat körül legalább 50 cm helyre van szükség.
- (HR)** Dimenzije temelja: Za ugradnju je potrebno najmanje 50 cm prostora oko temelja.

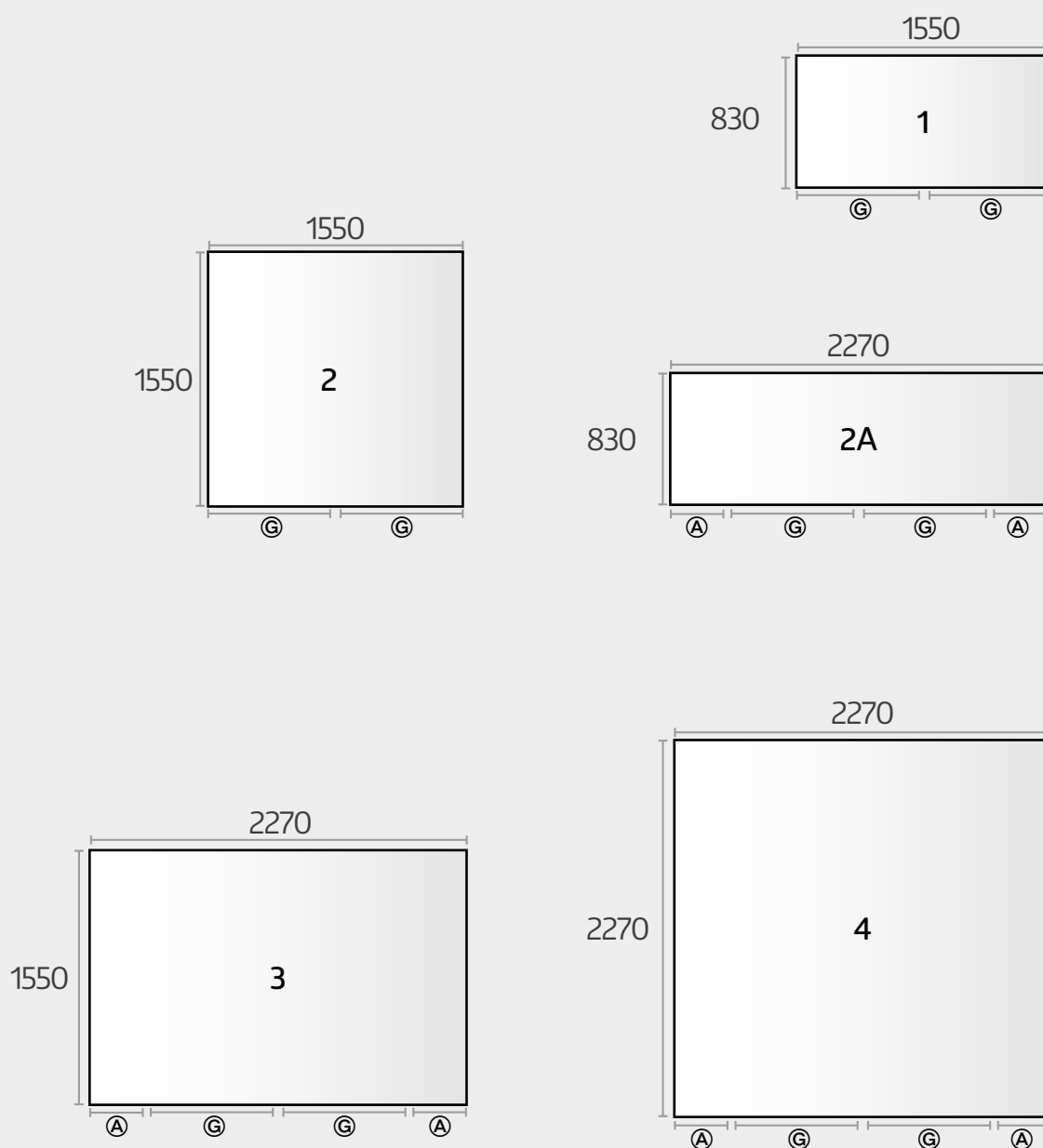

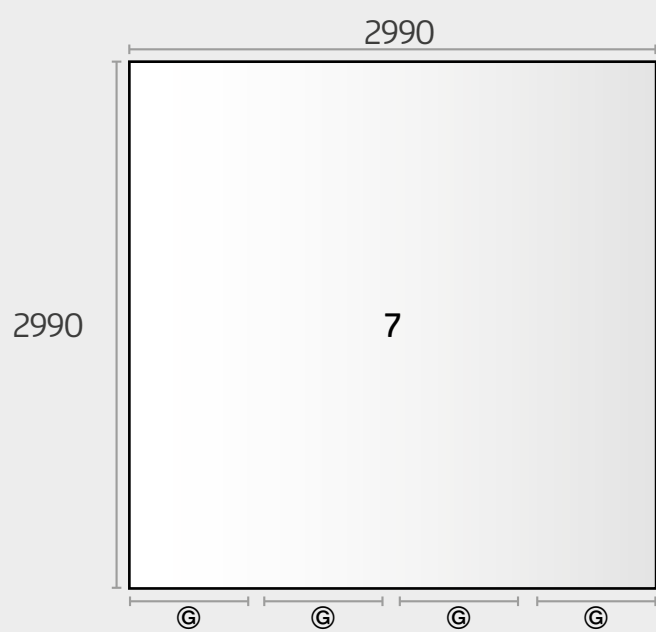
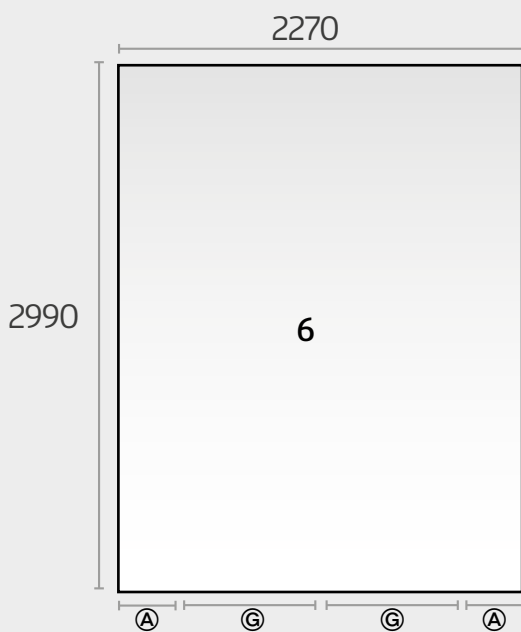
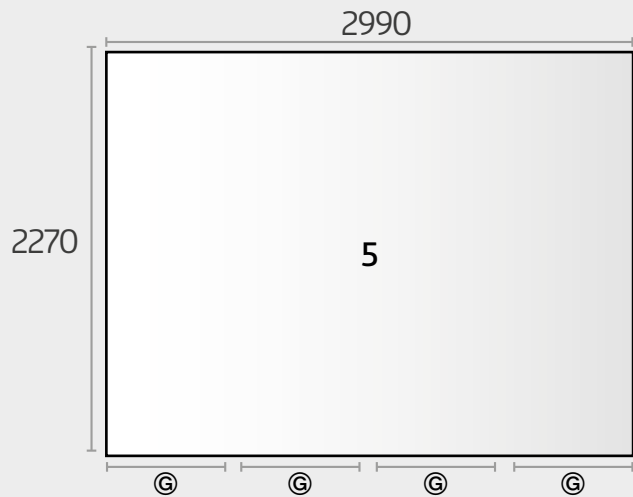
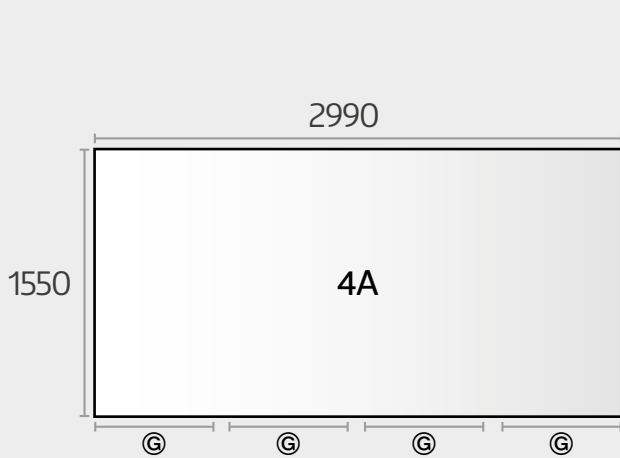

EINBAUMÖGLICHKEITEN DER TÜREN ANSTELLE VON WANDELEMENTEN!

- (GB)** The door can be installed instead of a side wall element!
- (FR)** La porte peut être installée sur le côté à la place d'une paroi latérale !
- (NL)** Inbouwmogelijkheden van de deuren i.p.v. de wandelementen
- (ES)** Es posible colocar las puertas en lugar de los paneles laterales.
- (IT)** Considerare la possibilità di montare una portastandard al posto di una parete laterale!
- (DK)** Døren kan monteres i stedet for et sidevæg element!
- (SE)** Installationsalternativ för dörrar istället för väggelement!
- (NO)** Dør kan installeres i stedet for et sideveggselement!
- (PL)** Opcje montażu drzwi zamiast elementów ściennych!
- (SK)** Dvere je možné nainštalovať miesto dielu bočnej steny!
- (SI)** Vrata lahko namestite namesto stranskega stenskega elementa!
- (CZ)** Dveře lze instalovat místo dílu boční stěny!
- (HU)** Az ajtó beépítési lehetőségek a falelemek helyett!
- (HR)** Vrata se mogu ugraditi umjesto elementa bočnog zida!

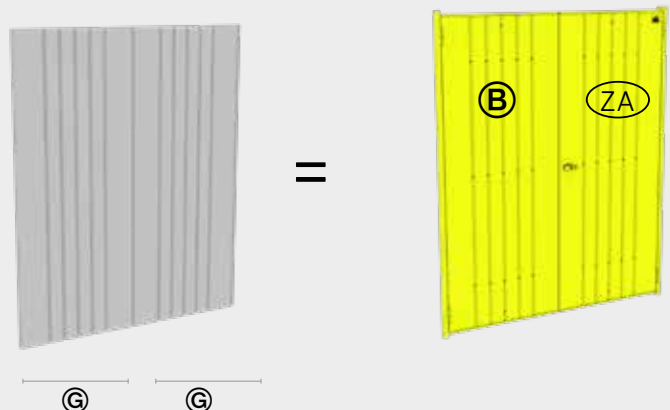

1 TÜR - PAKET

Doorpackage · Carton de portes · Deurpakket · Kit de puerta · Pacco porta · Dørpakke

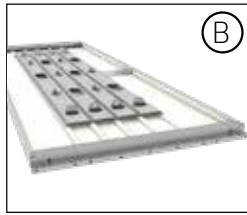
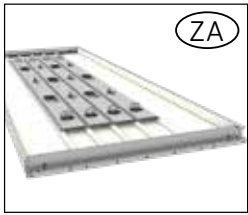

2 SEITENWAND - DACHPAKET

Side panel roof package · Carton de parois latérales · Zijwandpakket · Panel la teral · Pacco pareti laterali · Sidepladepakke

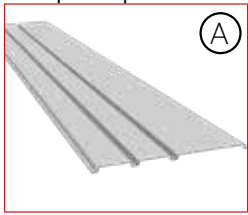

Nur für Größe 2A, 3, 4, 6
Only for size 2A, 3, 4, 6
Uniquement pour les taille 2A, 3, 4, 6
Alleen voor grootte 2A, 3, 4, 6
sólo para los tamaños 2A, 3, 4, 6
solo per misura 2A, 3, 4, 6
Kun for størrelse 2A, 3, 4, 6

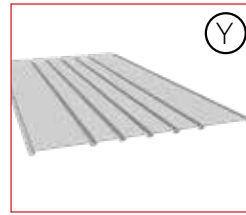
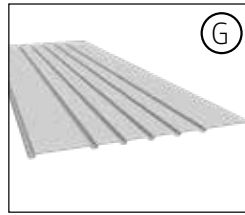

Nur für Größe 1, 2, 2A, 3, 4A
Only for size 1, 2, 2A, 3, 4A
Uniquement pour les taille 1, 2, 2A, 3, 4A
Alleen voor grootte 1, 2, 2A, 3, 4A
sólo para los tamaños 1, 2, 2A, 3, 4A
solo per misura 1, 2, 2A, 3, 4A
Kun for størrelse 1, 2, 2A, 3, 4A

2a SEITENWAND - PAKET

Side panel package · Carton de parois latérales · Zijwandpakket · Panel la teral · Pacco pareti laterali · Sidepladepakke

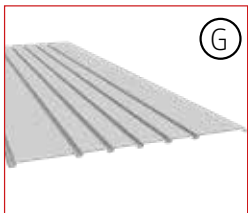

Nur für Größe 3, 4, 4A, 5, 6, 7
Only for size 3, 4, 4A, 5, 6, 7
Uniquement pour les taille 3, 4, 4A, 5, 6, 7
Alleen voor grootte 3, 4, 4A, 5, 6, 7
sólo para los tamaños 3, 4, 4A, 5, 6, 7
solo per misura 3, 4, 4A, 5, 6, 7
Kun for størrelse 3, 4, 4A, 5, 6, 7

3 PROFIL - PAKET

Profile package · Carton de profils · Profielpakket · Kit de perfiles · Pacco profili · Profilpakke

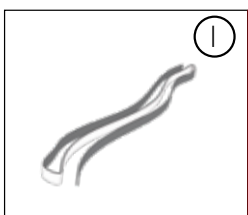
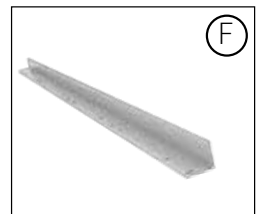
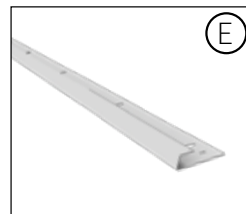
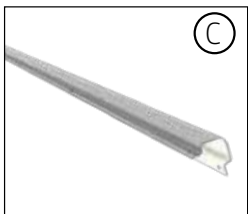

Nur für Größe 5 und 7
Only for size 5 and 7
Uniquement pour les taille 5 et 7
Alleen voor grootte 5 en 7
sólo para los tamaños 5 y 7
solo per misura 5 e 7
Kun for størrelse 5 og 7

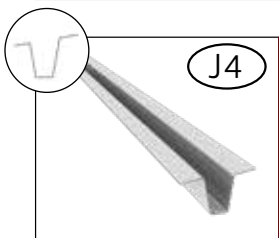
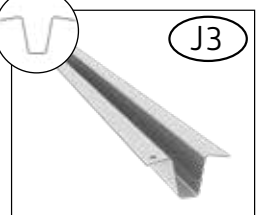
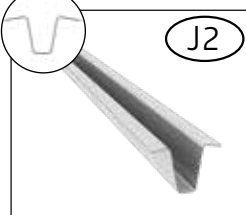
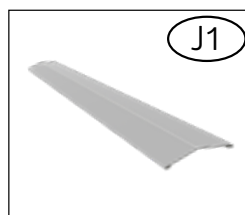

Nur für Größe 5 und 7
Only for size 5 and 7
Uniquement pour les taille 5 et 7
Alleen voor grootte 5 en 7
sólo para los tamaños 5 y 7
solo per misura 5 e 7
Kun for størrelse 5 og 7

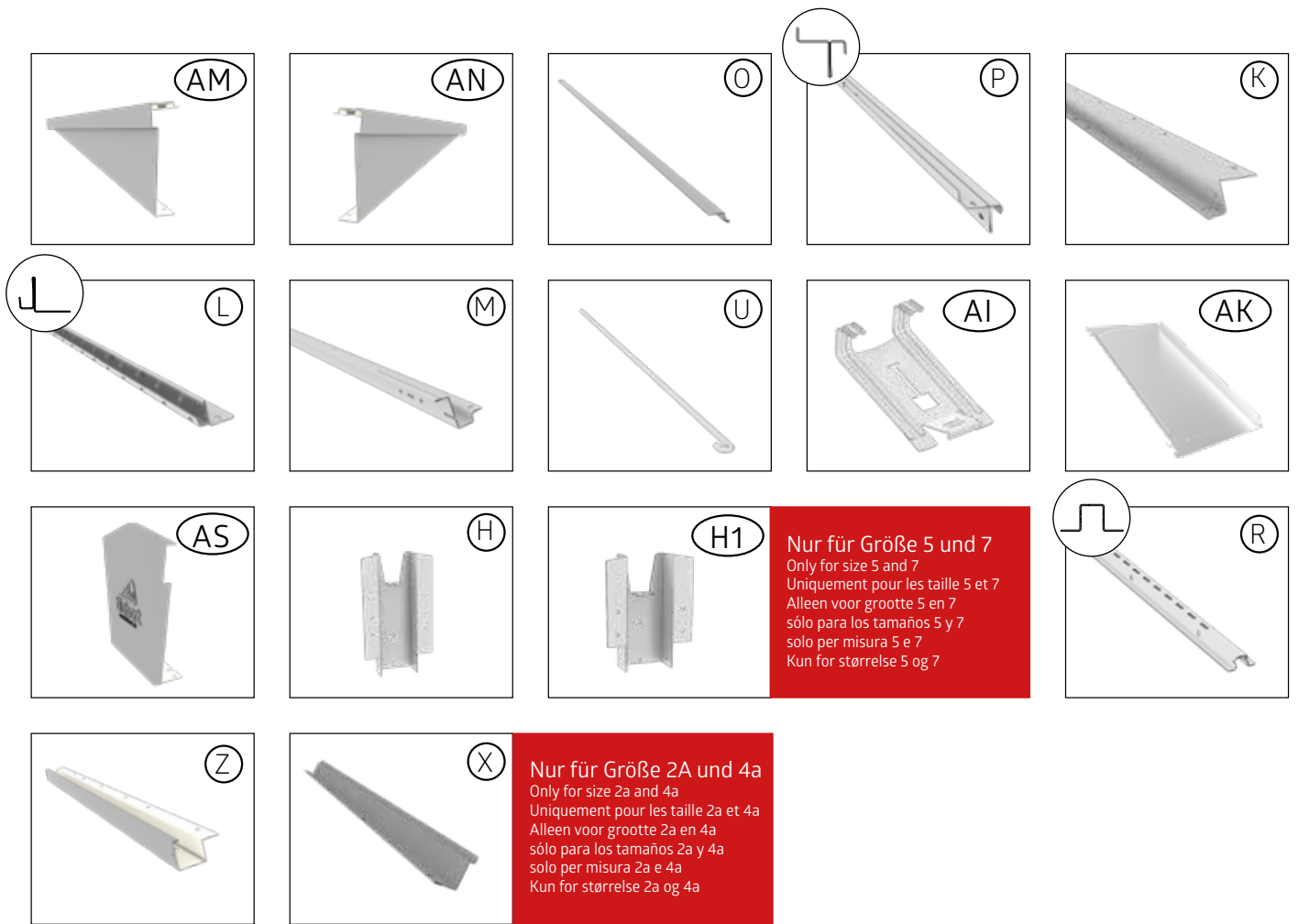

DACH - PAKET





roof panel package · carton de tôles de toit · dakplaatpakket · kit de paneles del tejado · pacco lamiera tetto · tagpladepakke



1.

Rückwand

Rear wall - Paroi arrière - Achterwand - Panel posterior - Parete posteriore - Bagplade

 <p>2/2a</p> <p>ⓐ</p>	<p>1: 2x 4A: 4x 2: 2x 5: 4x 2A: 3x 6: 3x 3: 3x 7: 4x 4: 3x</p>	 <p>3</p> <p>ⓐ</p>	<p>1: 1x 4A: 1x 2: 1x 5: 1x 2A: 1x 6: 1x 3: 1x 7: 1x 4: 1x</p>	 <p>3</p> <p>ⓐ</p>	<p>1: 1X(1490mm) 4A: 1X(2930mm) 2: 1X(1490mm) 5: 1X(2930mm) 2A: 1X(2210mm) 6: 1X(2210mm) 3: 1X (2210mm) 7: 1X(2930mm) 4: 1X (2210mm)</p>
 <p>3</p> <p>ⓐ</p>	<p>1: 1X(1490mm) 4A: 1X(2930mm) 2: 1X(1490mm) 5: 1X(2930mm) 2A: 1X(2210mm) 6: 1X(2210mm) 3: 1X (2210mm) 7: 1X(2930mm) 4: 1X (2210mm)</p>	<p>M4 x 10</p>  <p>ⓐ</p>	<p>1: 8x 4A: 16x 2: 8x 5: 16x 2A: 12x 6: 12x 3: 12x 7: 16x 4: 12x</p>		

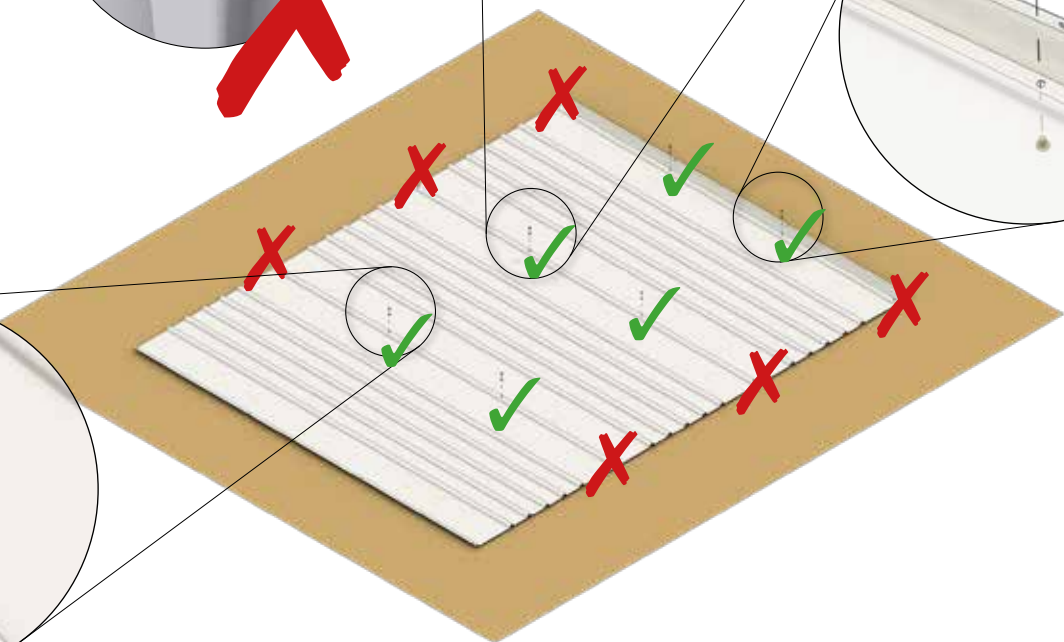
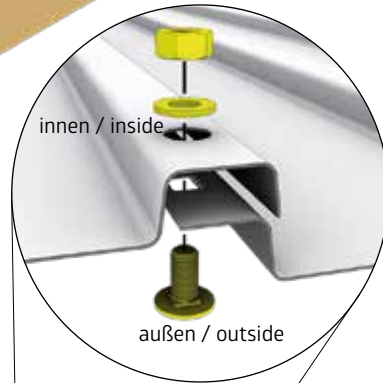
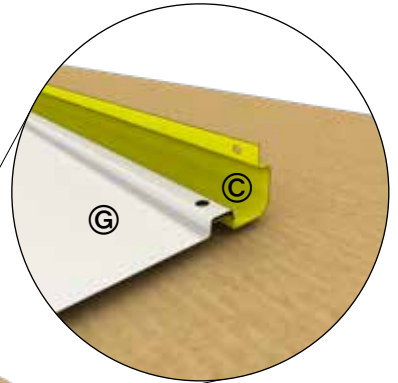
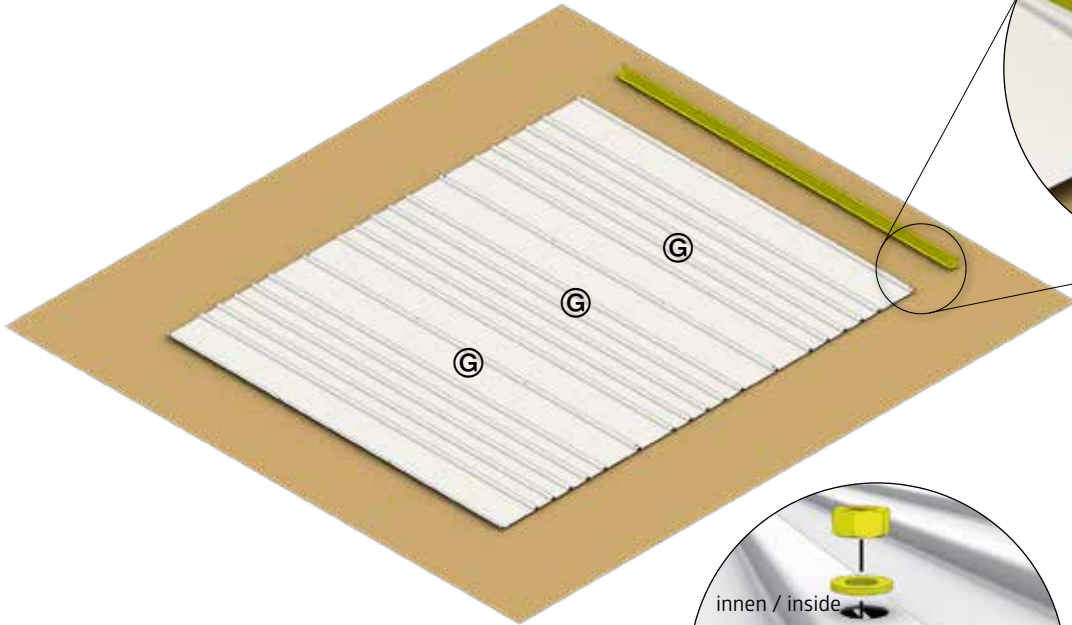

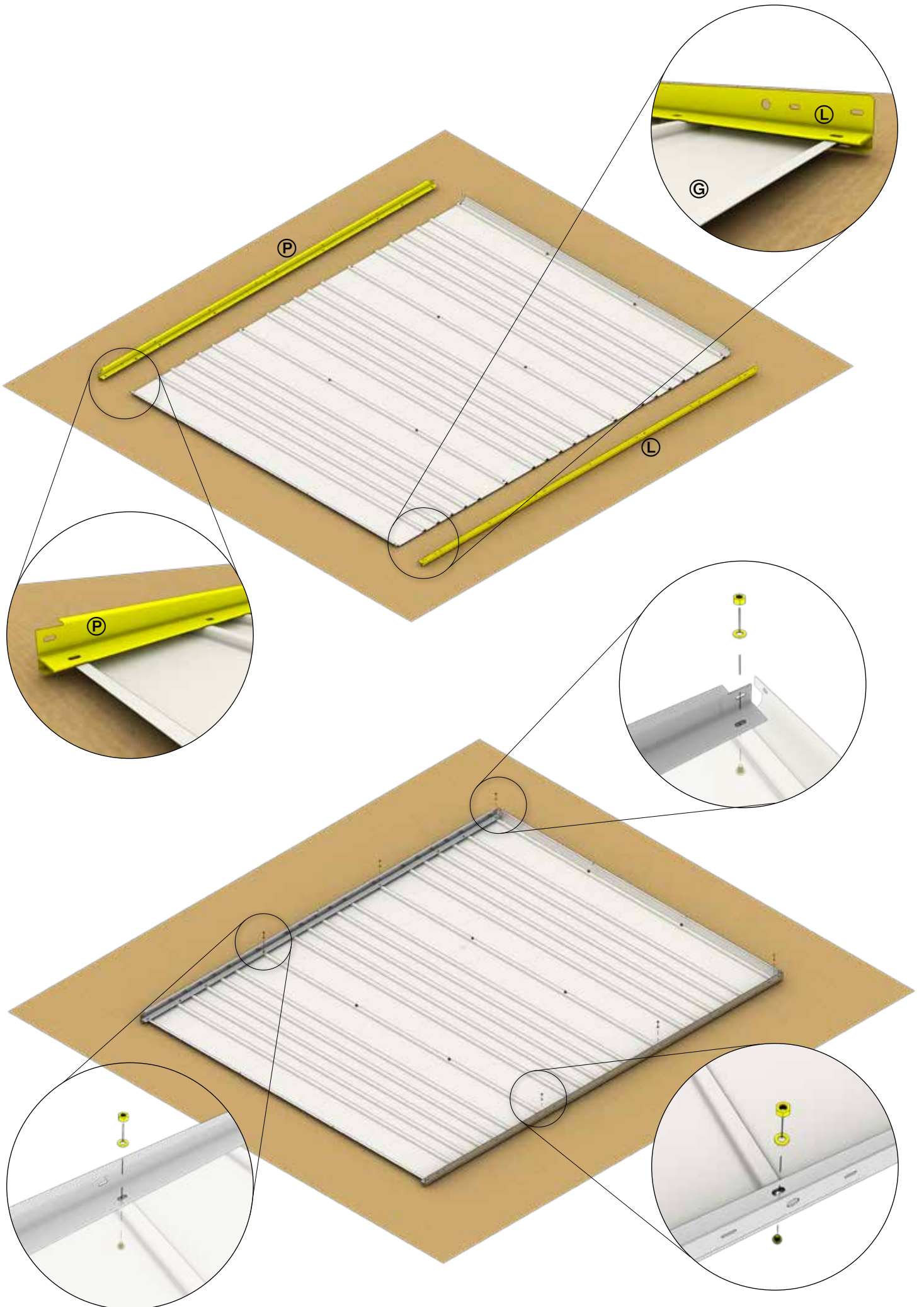









Nur für Größe 2A-7!

Only for size 2A-7 - Uniquement pour taille 2A-7 - Alleen voor maat 2A-7 - Sólo para los tamaños 2A-7 - Solo per misura 2A-7 - Kun for størrelse 2A-7

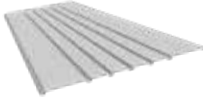

2. Türwand Door wall - Paroi de la porte - Deurwand - Panel de puerta - Parete della porta - Dørplade

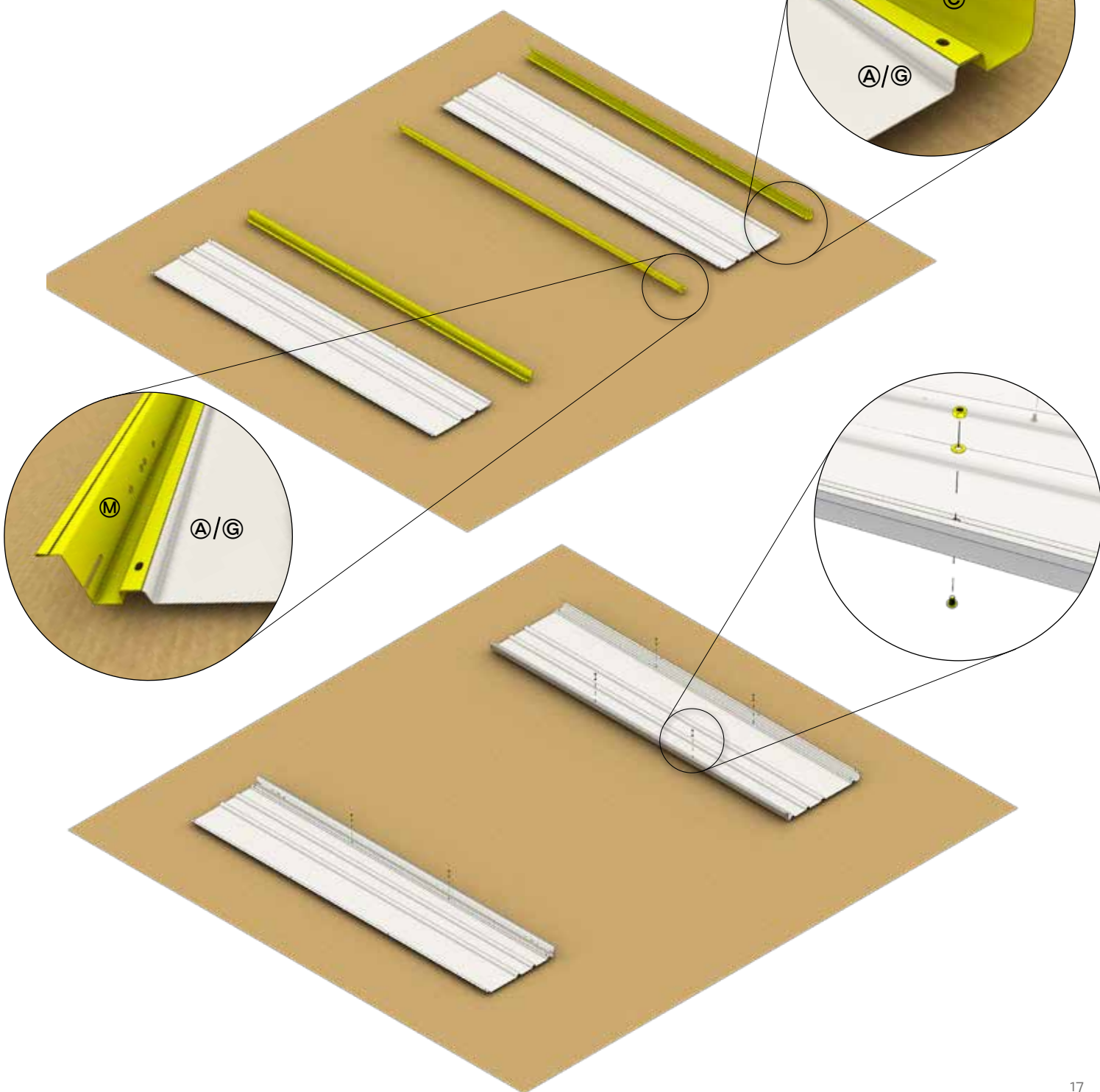
 (A)	 2 2A: 2x 3: 2x 4: 2x 6: 2x	 (C)	 3 2A: 1x 5: 1x 3: 1x 6: 1x 4: 1x 7: 1x 4A: 1x	 (M)	 3 2A: 2x 5: 2x 3: 2x 6: 2x 4: 2x 7: 2x 4A: 2x
M4 x 10  (D2)	2A: 6x 5: 6x 3: 6x 6: 6x 4: 6x 7: 6x 4A: 6x	 2/2a  (G)	4A: 2x 5: 2x 7: 2x		



Nur für Größe 2A-7!

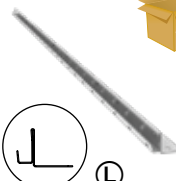

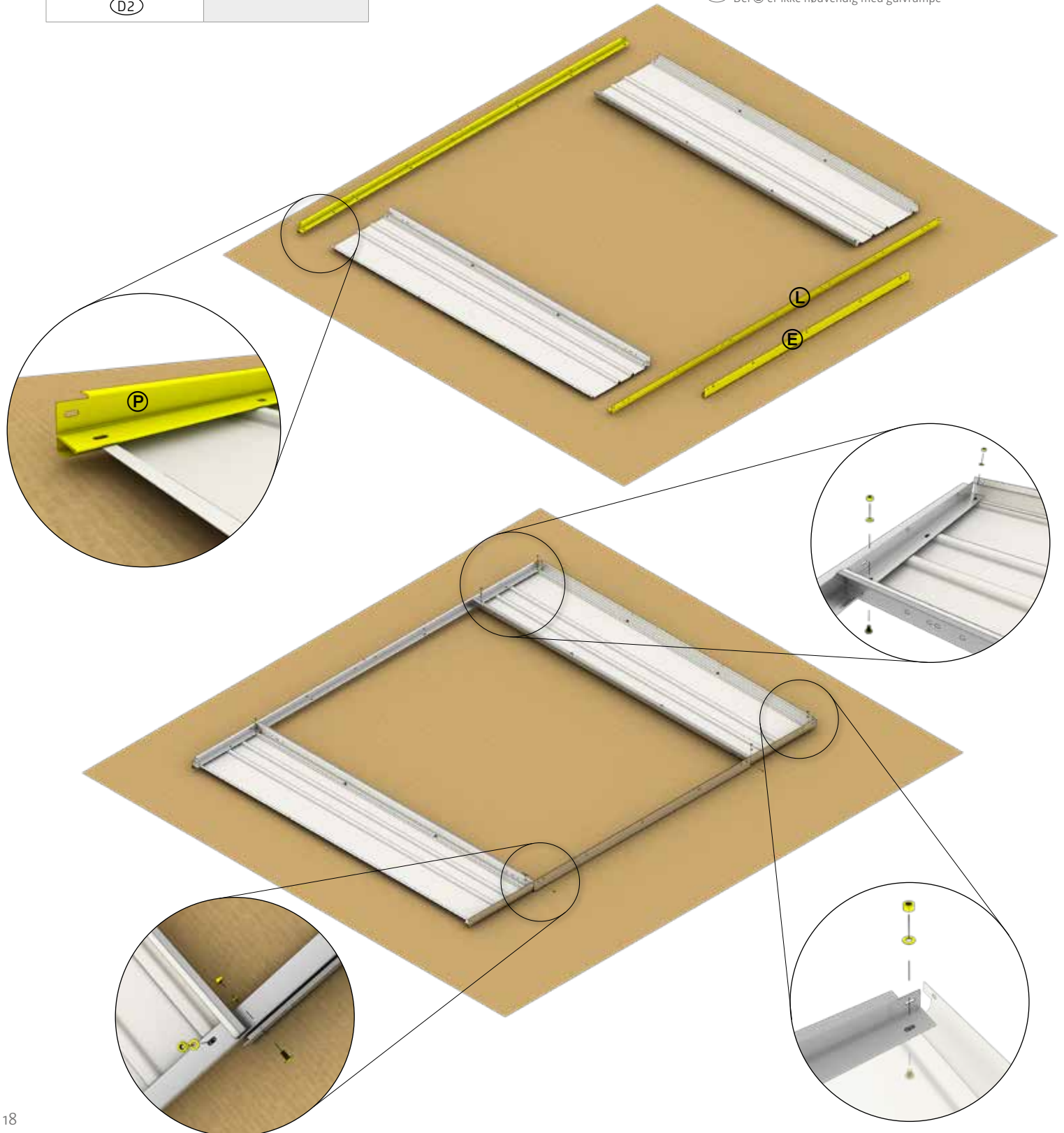

Only for size 2A-7 - Uniquement pour taille 2A-7 - Alleen voor maat 2A-7 - Sólo para los tamaños 2A-7 - Solo per misura 2A-7 - Kun for størrelse 2A-7

 <p>3</p> <p>Ⓟ</p>	<p>2A: 1x 5: 1x 3: 1x 6: 1x 4: 1x 7: 1x 4A: 1x</p>	 <p>3</p> <p>Ⓛ</p>	<p>1: 1x 4A: 1x 2: 1x 5: 1x 2A: 1x 6: 1x 3: 1x 7: 1x 4: 1x</p>	 <p>3</p> <p>ⓔ*</p>	<p>2A: 1x 5: 1x 3: 1x 6: 1x 4: 1x 7: 1x 4A: 1x</p>
<p>M4 x 10</p>  <p>ⓓ2</p>	<p>2A: 8x 5: 8x 3: 8x 6: 8x 4: 8x 7: 8x 4A: 8x</p>	<p>* Teil ⓔ entfällt bei Bodenschwellenrampe ⓖⓔ Part ⓔ does not apply to threshold access ramp ⓕⓚ La partie ⓔ ne s'applique pas au seuil de rampe ⓃⓁ Deel ⓔ is niet van toepassing op Oprijplaat ⓔⓈ Parte ⓔ no se aplica con la rampa de acceso ⓔⓂ Parte ⓔ non si applica alla rampa da soglia ⓓⓀ Del ⓔ er ikke nødvendig med gulvrampe</p>			



Nur für Größe 2A-7!

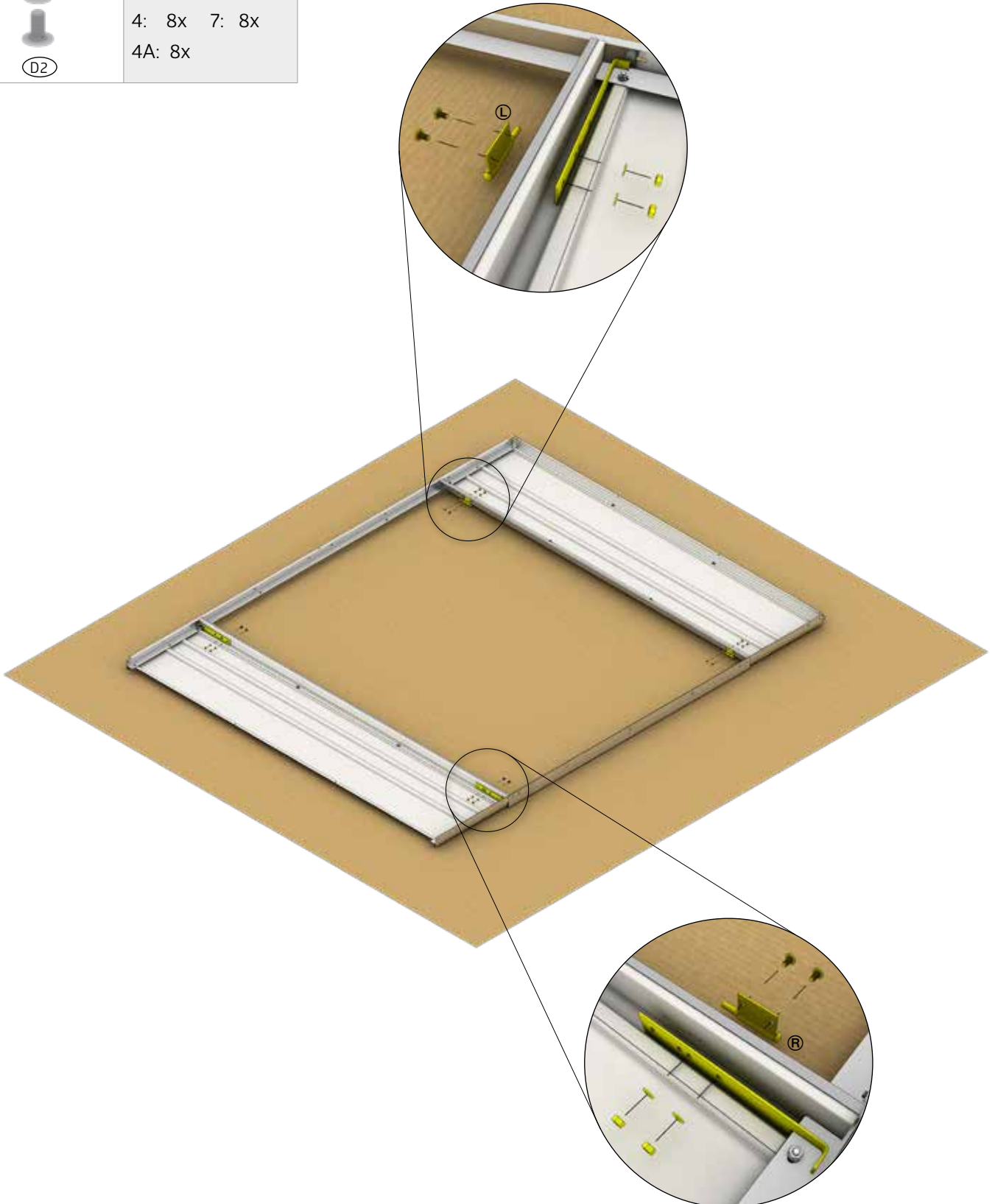

Only for size 2A-7 - Uniquement pour taille 2A-7 - Alleen voor maat 2A-7 - Sólo para los tamaños 2A-7 - Solo per misura 2A-7 - Kun for størrelse 2A-7

 <p>(D1)</p>	<p>2A: 2x 5: 2x 3: 2x 6: 2x 4: 2x 7: 2x 4A: 2x</p>	 <p>(D1)</p>	<p>2A: 2x 5: 2x 3: 2x 6: 2x 4: 2x 7: 2x 4A: 2x</p>	 <p>(D1)</p>	<p>2A: 4x 5: 4x 3: 4x 6: 4x 4: 4x 7: 4x 4A: 4x</p>
<p>M4 x 10</p>  <p>(D2)</p>	<p>2A: 8x 5: 8x 3: 8x 6: 8x 4: 8x 7: 8x 4A: 8x</p>				





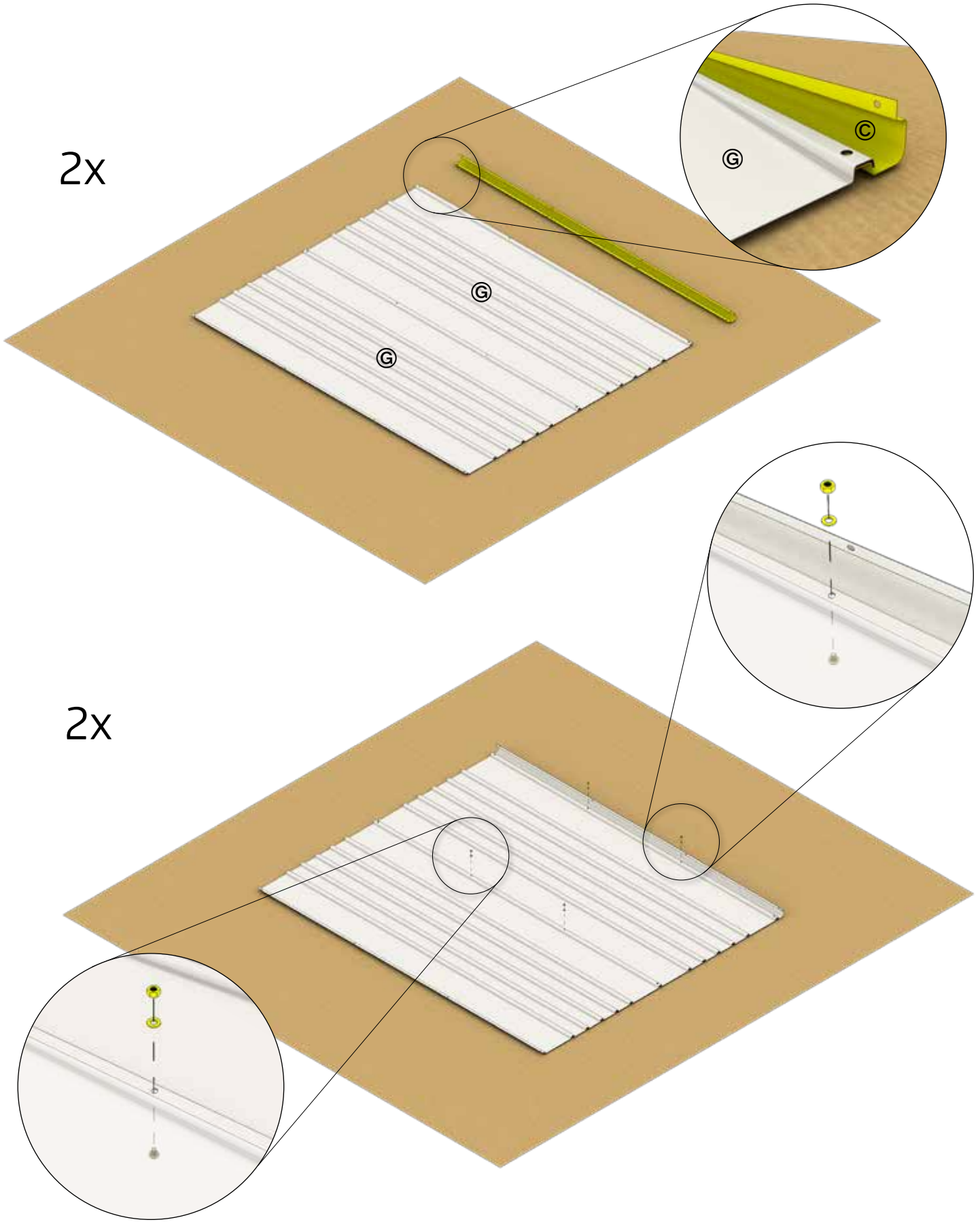

3. Seitenwand 2x

Side wall 2x - Paroi latérale 2x - Zijwand 2x - panel lateral 2x - Parete laterale 2x - Sideplade 2x

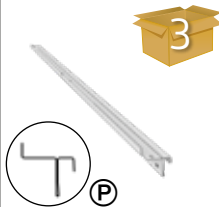
 <p>2/2a</p> <p>©</p>	1: 2x	4A: 4x	 <p>3</p> <p>©</p>	1: 2x	4A: 2x	 <p>M4x10</p> <p>D2</p>	1: 4x	4A: 8x
	2: 4x	5: 6x		2: 2x	5: 2x		2: 8x	5: 12x
	2A: 2x	6: 8x		2A: 2x	6: 2x		2A: 4x	6: 16x
	3: 4x	7: 8x		3: 2x	7: 2x		3: 8x	7: 16x
	4: 6x	4: 2x		4: 12x				

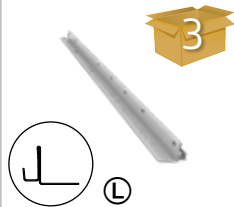

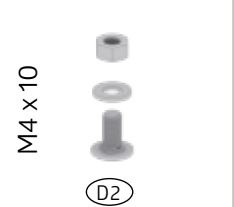
	 <p>1: 2x 4A: 2x 2: 2x 5: 2x 2A: 2x 6: 2x 3: 2x 7: 2x 4: 2x</p>		 <p>1: 2x 4A: 2x 2: 2x 5: 2x 2A: 2x 6: 2x 3: 2x 7: 2x 4: 2x</p>	<p>M4 x 10</p> 	<p>1: 4x 4A: 12x 2: 8x 5: 12x 2A: 4x 6: 16x 3: 8x 7: 16x 4: 12x</p>
---	--	--	--	---	---

2x

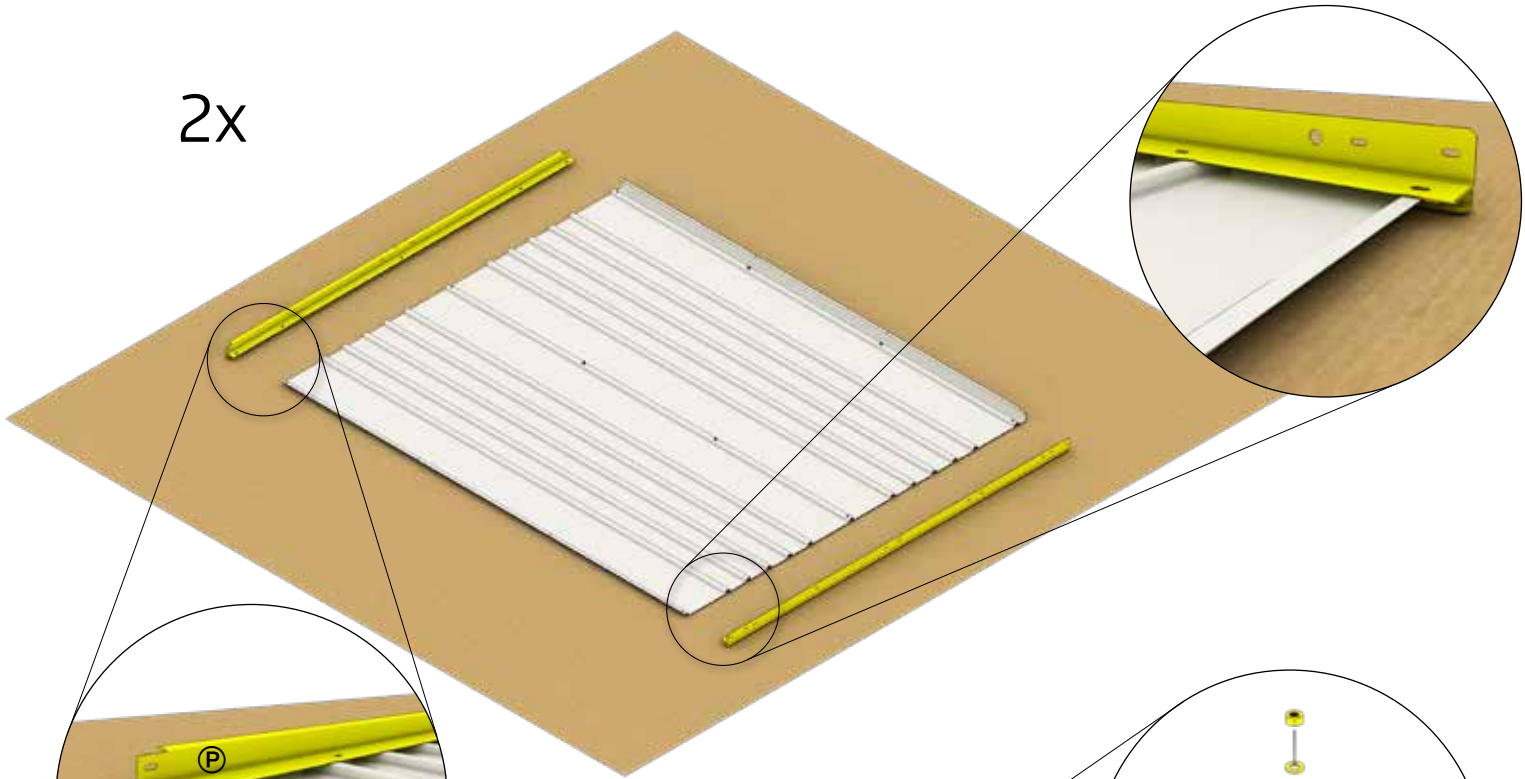

2x

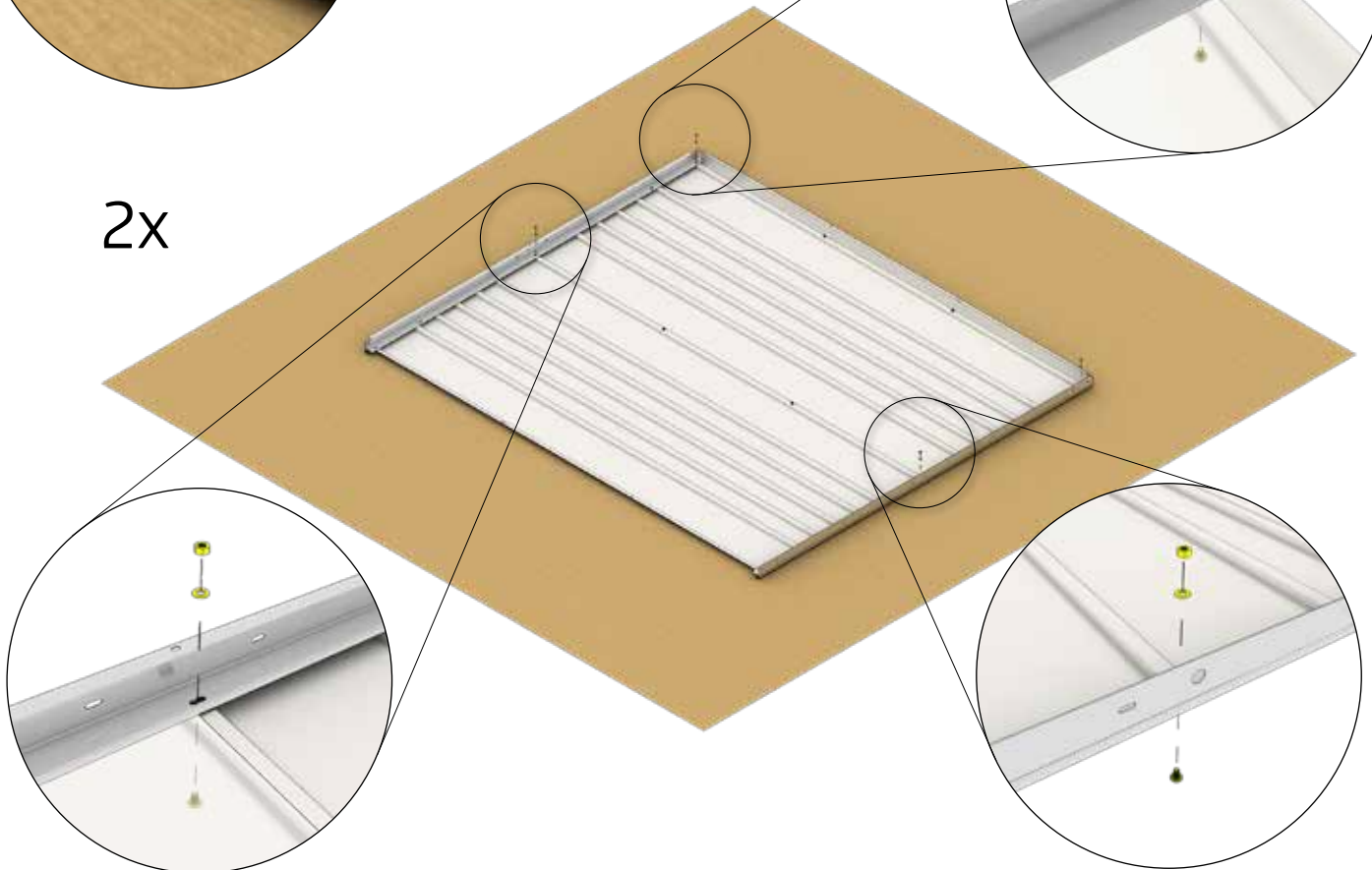



Bodenrahmen

Floor Frame - Cadre de sol - Bodemframe - Marco de suelo - Telaio perimetrale - Bundramme

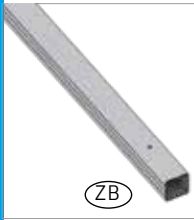

ZB

- | | |
|-------------------------------|--------------------------------|
| 1: 2x (700mm)
2x (1420mm) | 4A: 2x (1420mm)
2x (2860mm) |
| 2: 4x (1420mm) | 5: 2x (2140mm)
2x (2860mm) |
| 2A: 2x (700mm)
2x (2140mm) | 6: 2x (2140mm)
2x (2860mm) |
| 3: 2x (1420mm)
2x (2140mm) | 7: 4x (2860mm) |
| 4: 4x (2140mm) | |



ZC

- | | |
|--------|--------|
| 1: 4x | 4A: 4x |
| 2: 4x | 5: 4x |
| 2A: 4x | 6: 4x |
| 3: 4x | 7: 4x |
| 4: 4x | |

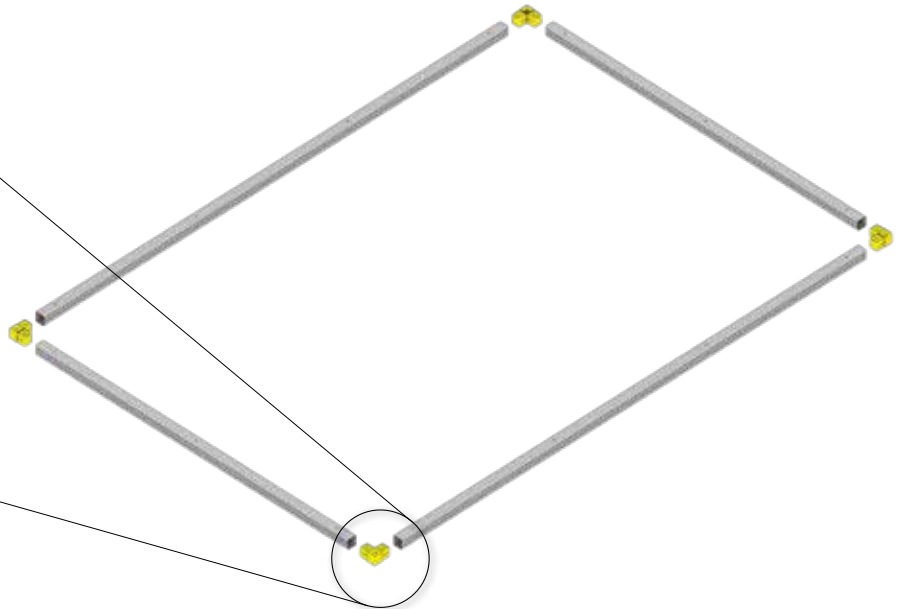
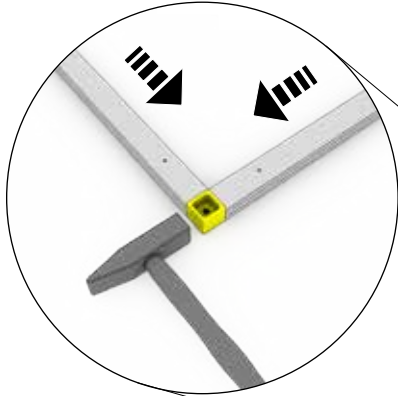

ZD

- | | |
|--------|--------|
| 1: 1x | 4A: 1x |
| 2: 1x | 5: 1x |
| 2A: 1x | 6: 1x |
| 3: 1x | 7: 1x |
| 4: 1x | |

6,3 x 22



ZF

- | | |
|--------|--------|
| 1: 1x | 4A: 1x |
| 2: 1x | 5: 1x |
| 2A: 1x | 6: 1x |
| 3: 1x | 7: 1x |
| 4: 1x | |

M4 x 10



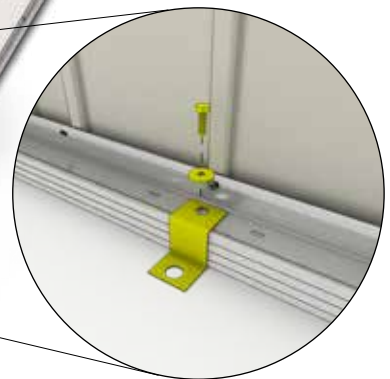
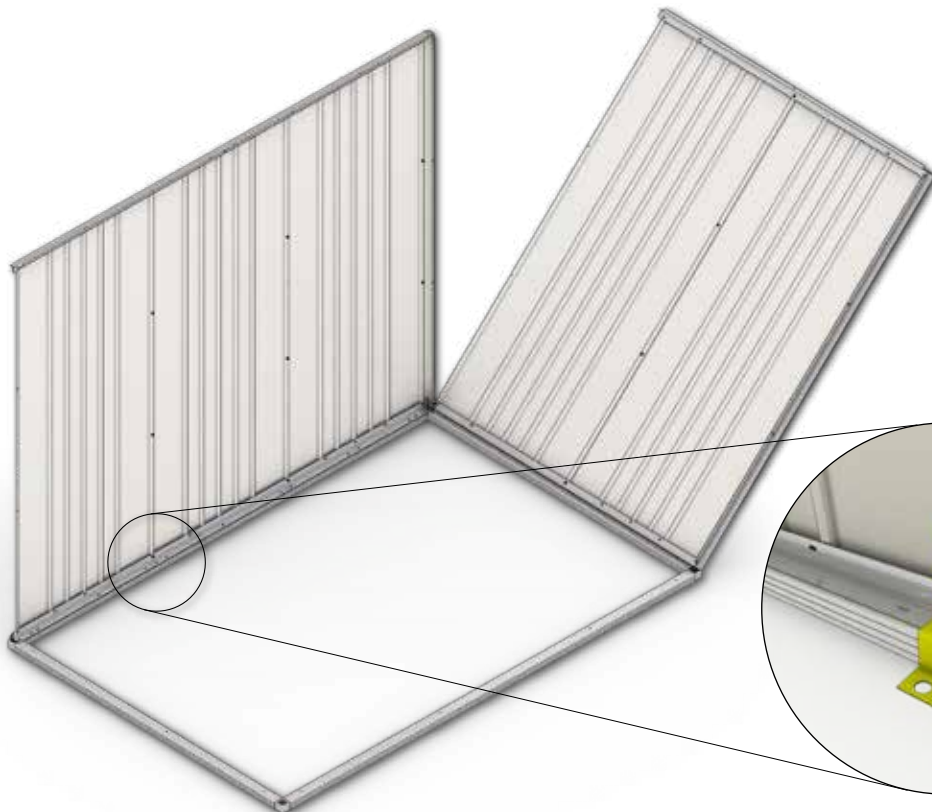

D2

- | | |
|--------|--------|
| 1: 1x | 4A: 1x |
| 2: 1x | 5: 1x |
| 2A: 1x | 6: 1x |
| 3: 1x | 7: 1x |
| 4: 1x | |



Bodenrahmen

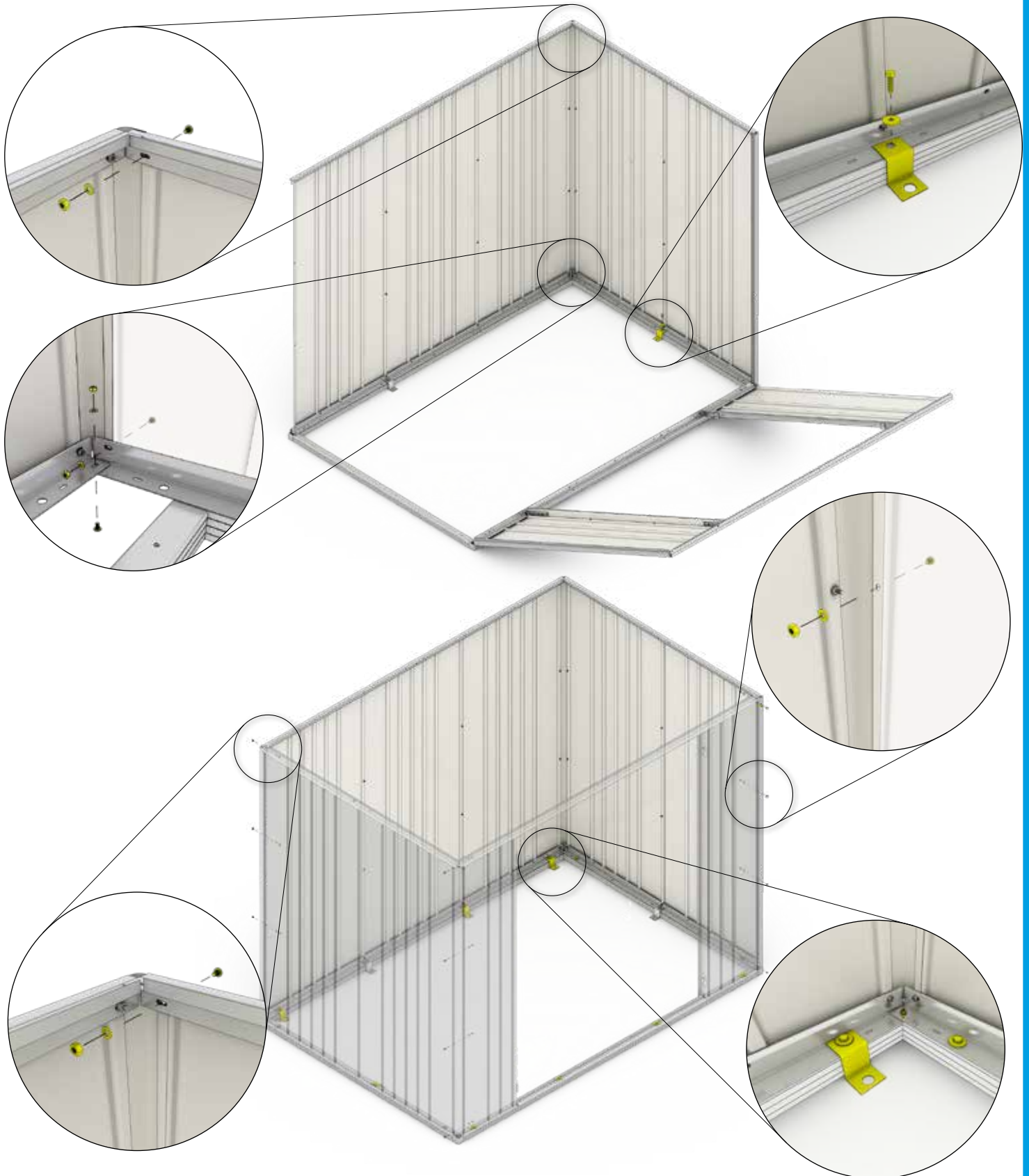

Floor Frame - Cadre de sol - Bodemframe - Marco de suelo - Telaio perimetrale - Bundramme

 <p>(ZD)</p>	1: 4x	4A: 8x	 <p>M4 x 10</p> <p>(D2)</p>	1: 16x	4A: 16x	 <p>6,3 x 22</p> <p>(ZF)</p>	1: 15x	4A: 15x
	2: 6x	5: 10x		2: 16x	5: 16x		2: 15x	5: 15x
	2A: 6x	6: 10x		2A: 16x	6: 16x		2A: 15x	6: 15x
	3: 8x	7: 10x		3: 16x	7: 16x		3: 15x	7: 15x
	4: 8x			4: 16x			4: 15x	







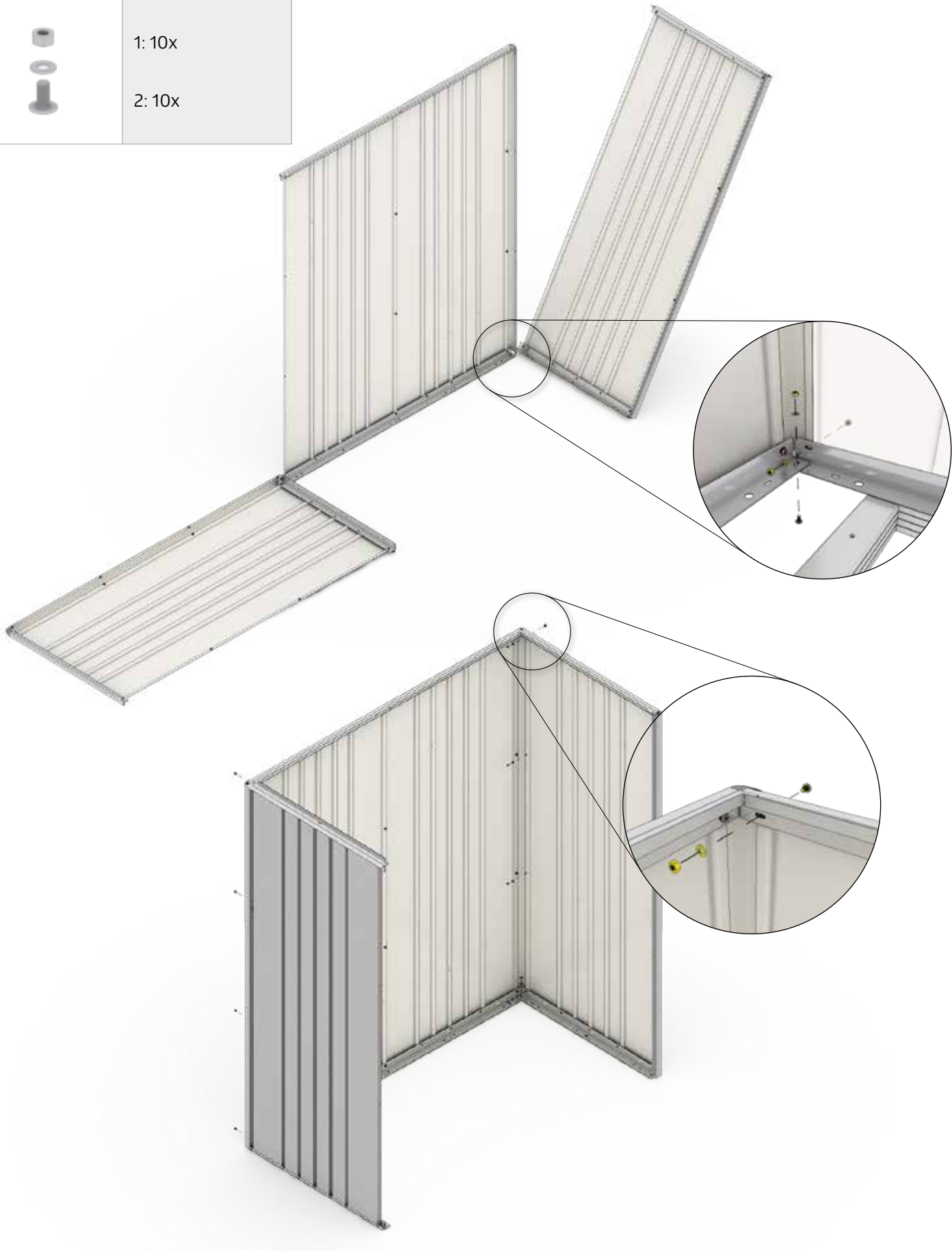

Nur für Größe 1 und 2

Only for size 1 and 2 - Uniquement pour taille 1 et 2 - Alleen voor maat 1 en 2 - Sólo para los tamaños 1 y 2 - Solo per misura 1 e 2 - Kun for størrelse 1 og 2

M4 x 10		1: 10x
		2: 10x



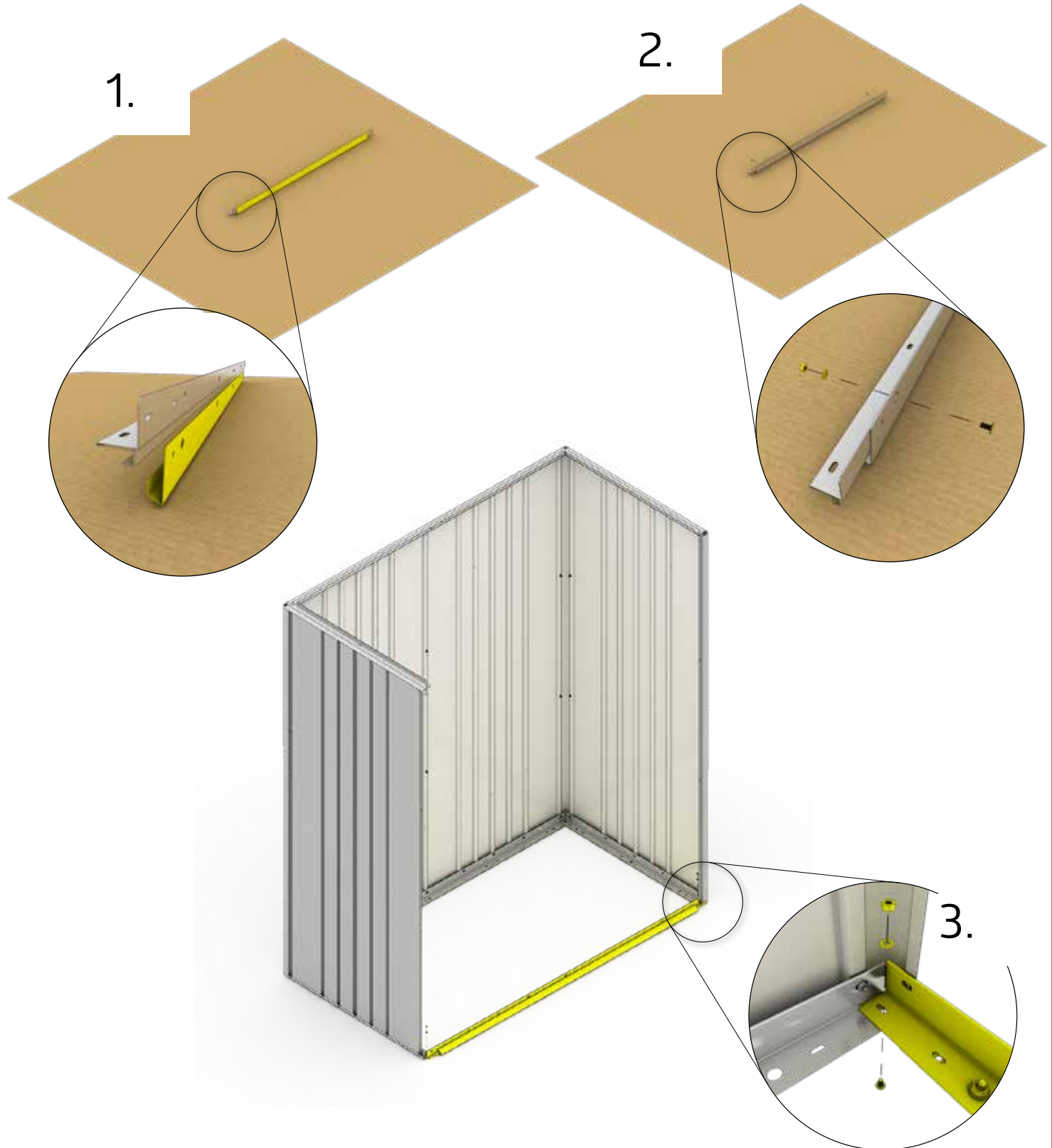

M4 x 10		1: 4x	 	1: 1x	 	1: 1x
		2: 4x		 Ⓛ		2: 1x





Nur für Größe 1 und 2

Only for size 1 and 2 - Uniquement pour taille 1 et 2 - Alleen voor maat 1 en 2 - Sólo para los tamaños 1 y 2 - Solo per misura 1 e 2 - Kun for størrelse 1 og 2

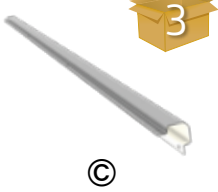
M4 x 10 	1: 9x		1: 2x		1: 1x
	2: 9x		2: 2x		2: 1x

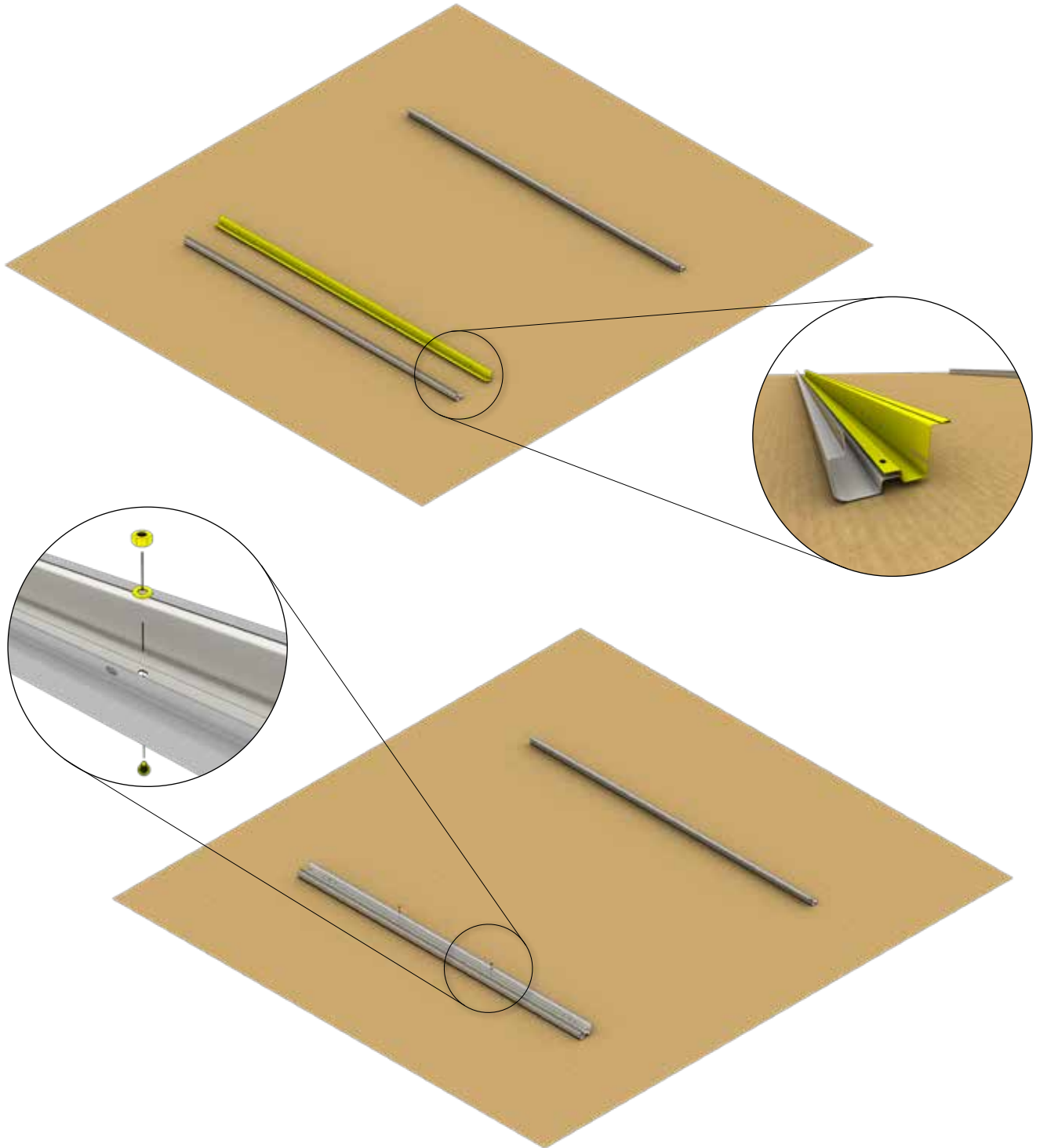

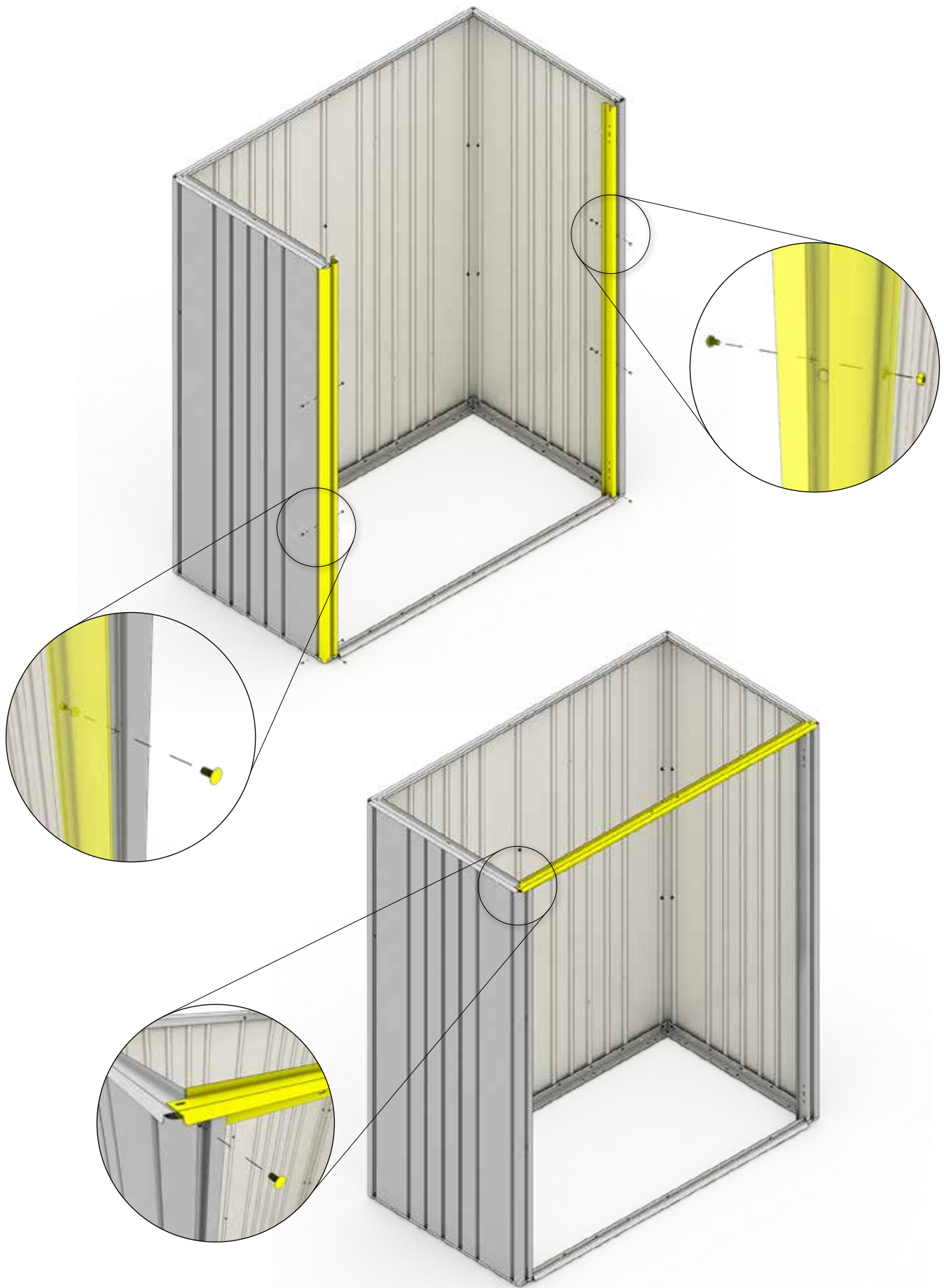







Nur für Größe 1 und 2

Only for size 1 and 2 - Uniquement pour taille 1 et 2 - Alleen voor maat 1 en 2 - Sólo para los tamaños 1 y 2 - Solo per misura 1 e 2 - Kun for størrelse 1 og 2

 (D1)	1: 2x 2: 2x	 (D1)	1: 2x 2: 2x	 (D1)	1: 4x 2: 4x
M4 x 10 	1: 10x 2: 10x				

1.

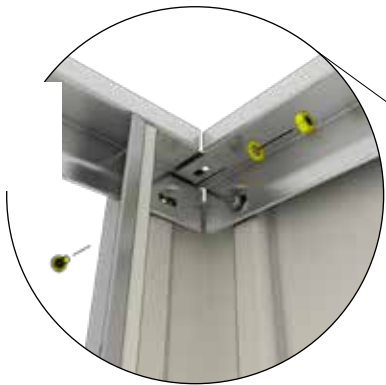

2.

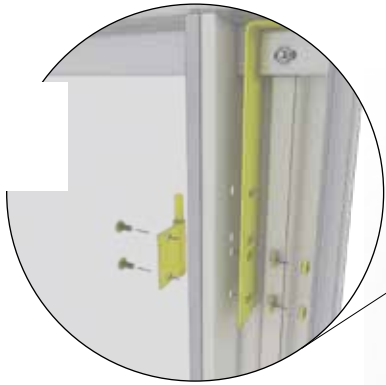

3.

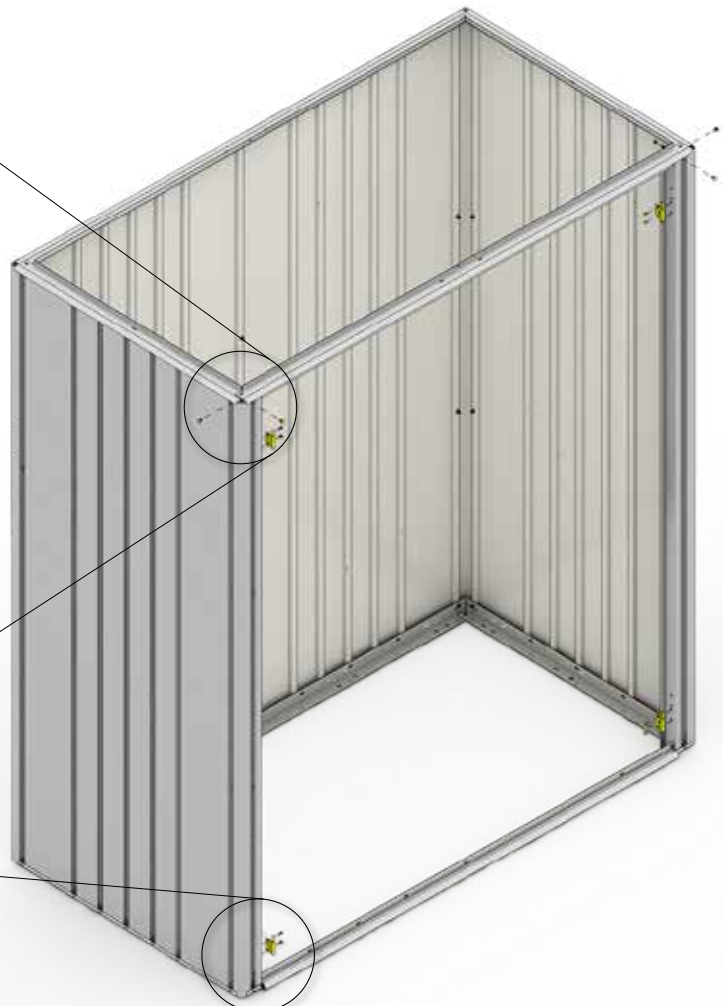
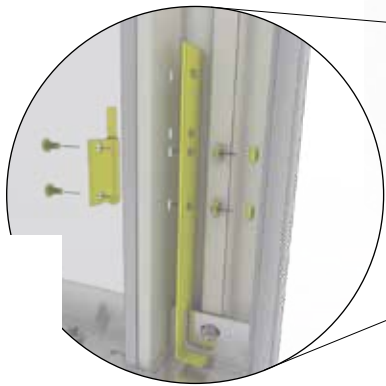

4.

M4 x 10



2A: 20x	5: 20x
3: 20x	6: 20x
4: 20x	7: 20x
4A: 20x	



D1

2A: 2x	5: 2x
3: 2x	6: 2x
4: 2x	7: 2x
4A: 2x	

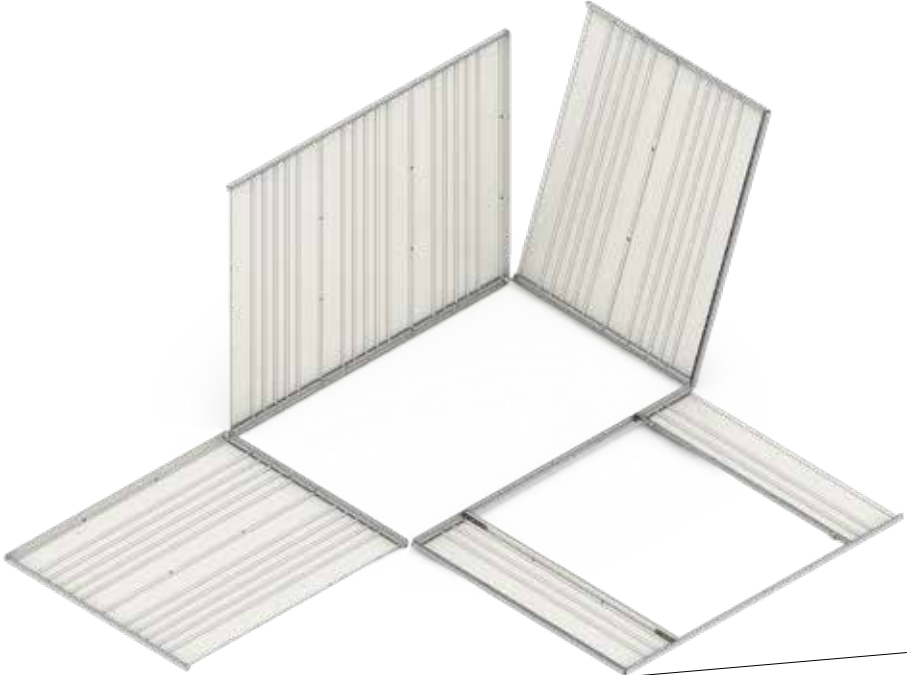

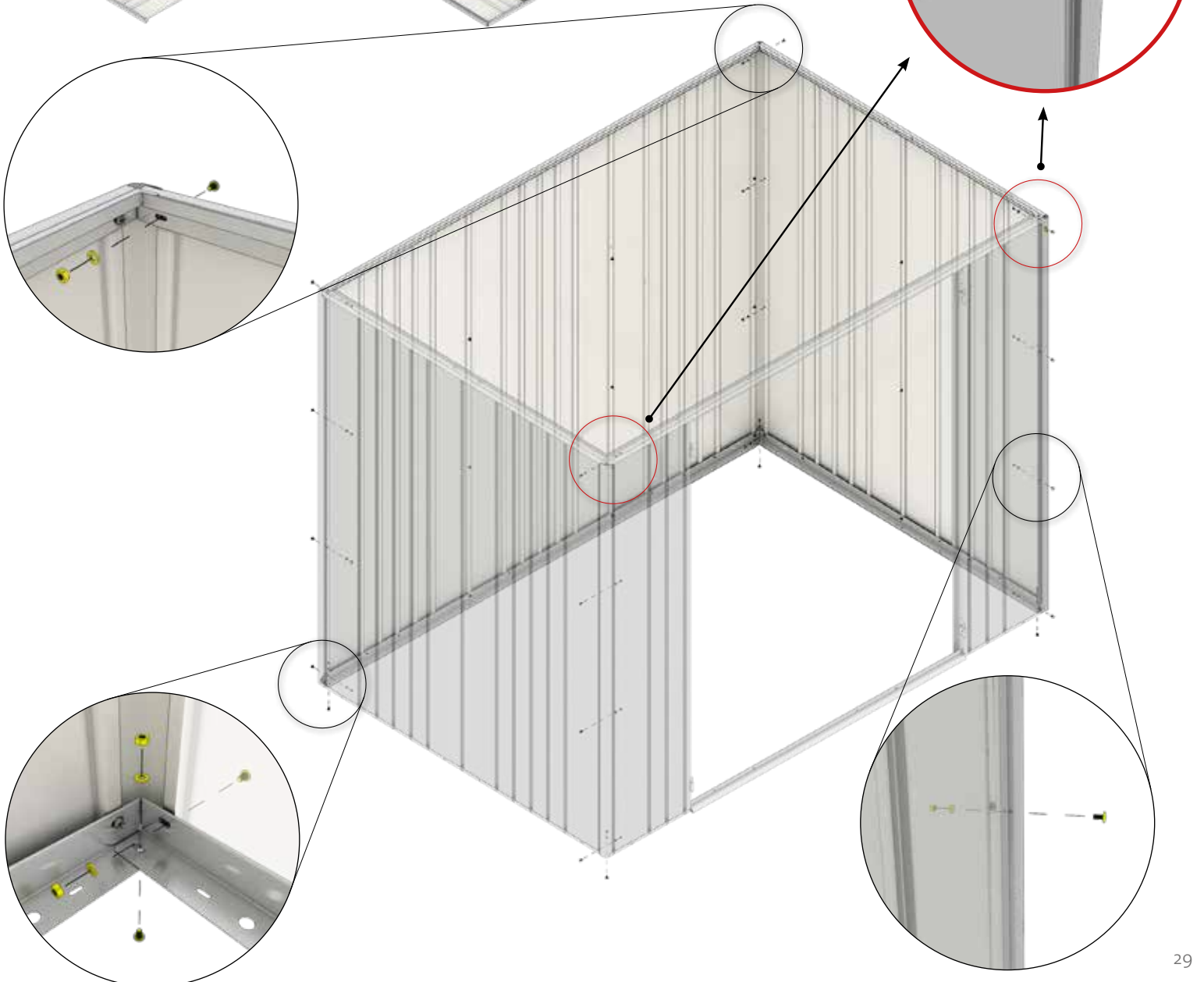

Nur für Größe 2A-7!

Only for size 2A-7
 Uniquement pour taille 2A-7
 Alleen voor maat 2A-7
 Sólo para el tamaño 2A-7
 Solo per misura 2A-7
 Kun for størrelse 2A-7



Nur für Größe 5 und 7

Only for size 5 and 7 - Uniquement pour taille 5 et 7 - Alleen voor maat 5 en 7 - Sólo para los tamaños 5 y 7 - Solo per misura 5 e 7 - Kun for størrelse 5 og 7

 <p>Ⓜ</p>	<p>5: 2x 7: 2x</p>	 <p>Ⓜ1</p>	<p>5: 4x 7: 4x</p>	<p>M4 x 10</p>  <p>Ⓜ2</p>	<p>5: 16x 7: 16x</p>
--	------------------------	---	------------------------	--	--------------------------

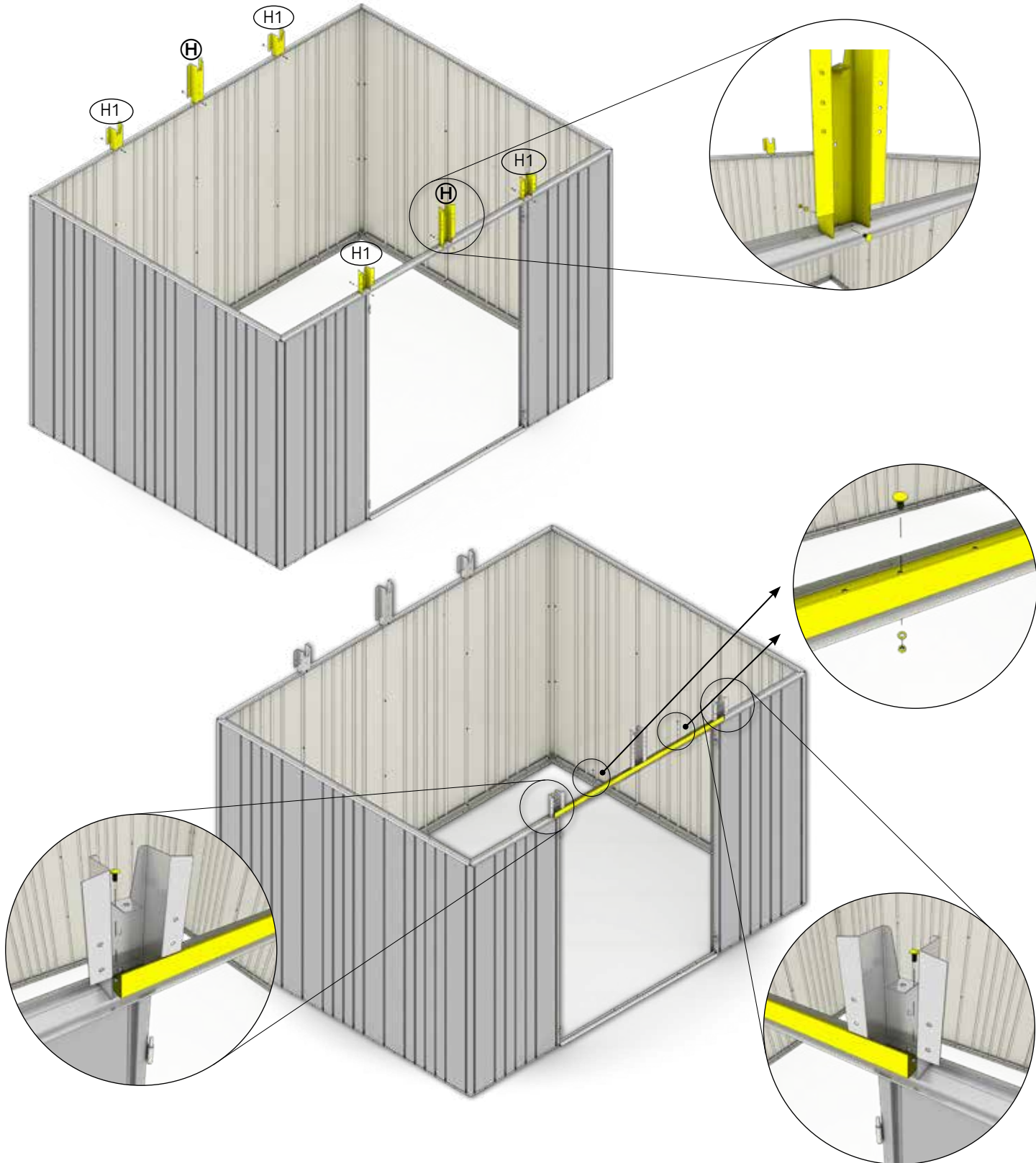



Nur für Größe 5 und 7

Only for size 5 and 7 - Uniquement pour taille 5 et 7 - Alleen voor maat 5 en 7 - Sólo para los tamaños 5 y 7 - Solo per misura 5 e 7 - Kun for størrelse 5 og 7

<p>ⓕ</p>	<p>5: 1x 7: 1x</p>	<p>ⓙ3</p>	<p>5: 1x 7: 1x</p>	<p>ⓙ4</p>	<p>5: 2x 7: 2x</p>
<p>M4 x 10</p> <p>ⓓ2</p>	<p>5: 10x 7: 10x</p>	<p>ⓔ</p>	<p>5: 4x 7: 4x</p>		

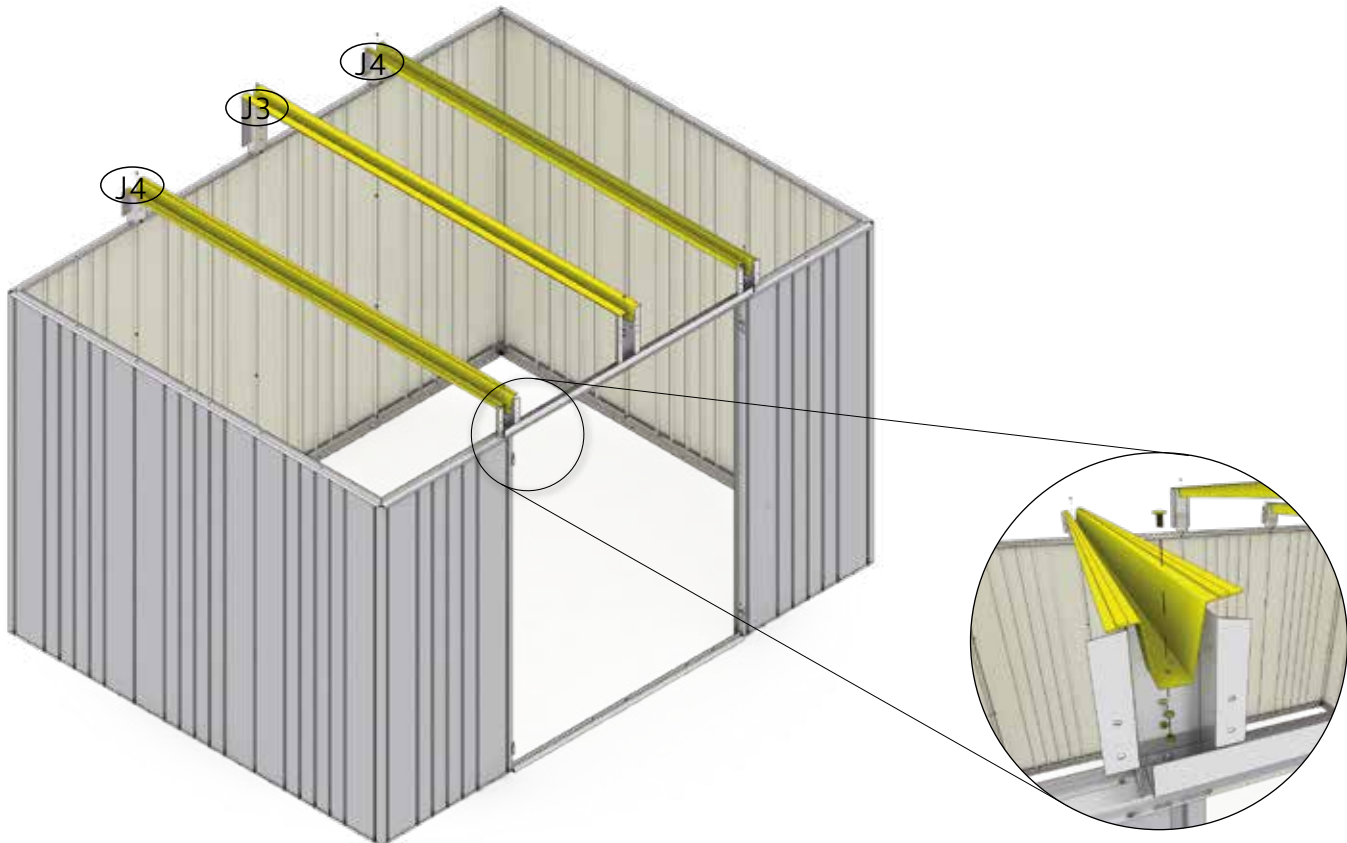
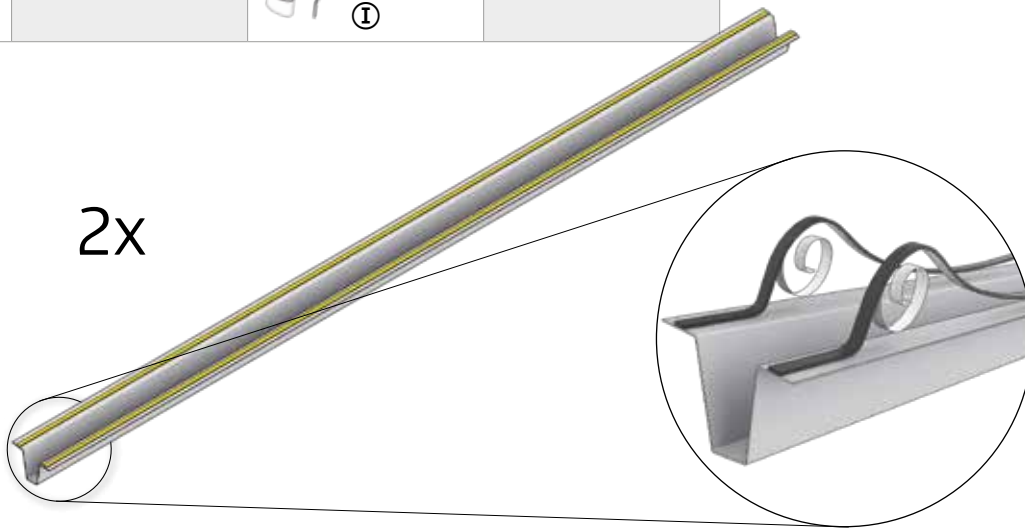

5.



- 1: 2x 4A: 2x
- 2: 2x 5: 2x
- 2A: 2x 6: 2x
- 3: 2x 7: 2x
- 4: 2x





M4 x 10

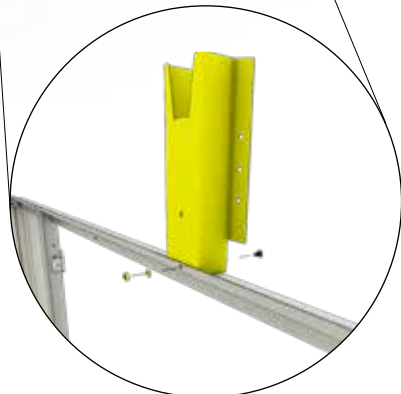
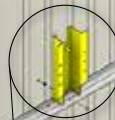
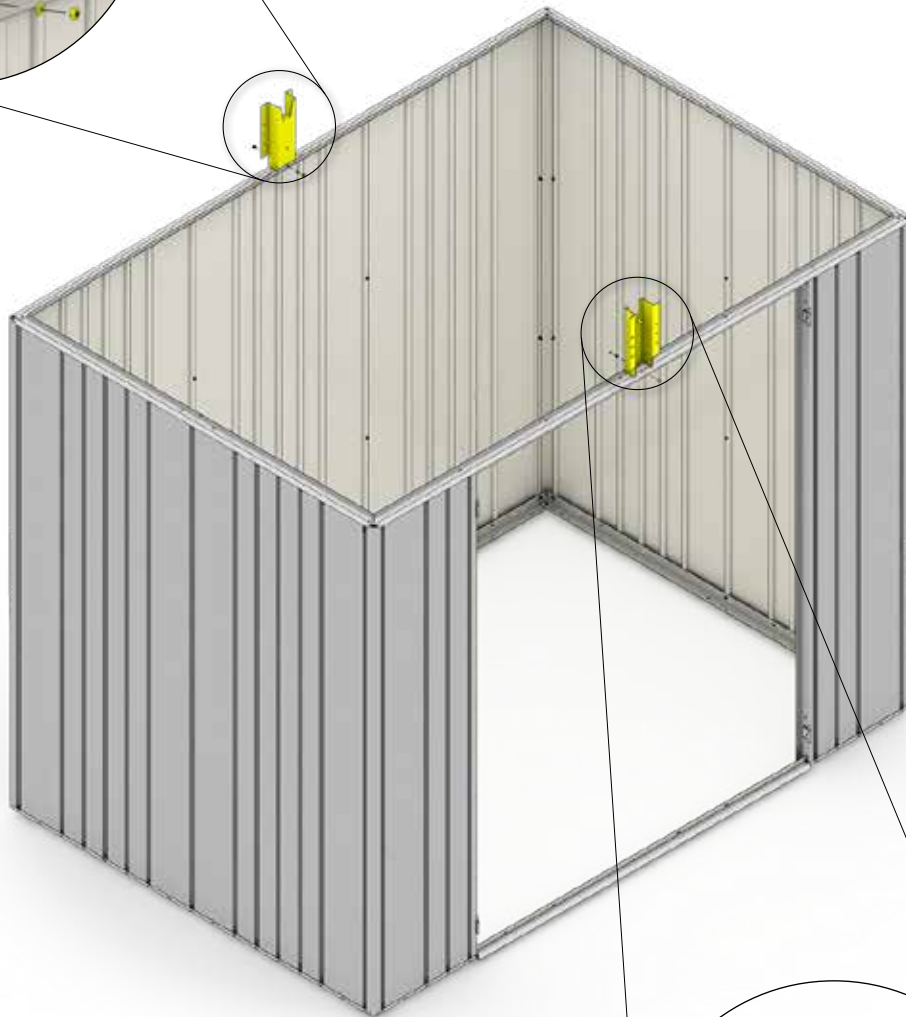
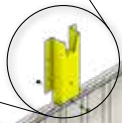
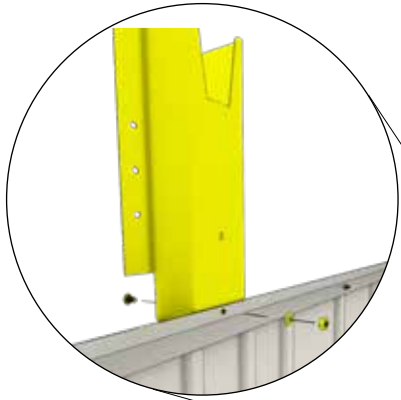

- 1: 2x 4A: 2x
- 2: 2x 5: 2x
- 2A: 2x 6: 2x
- 3: 2x 7: 2x
- 4: 2x





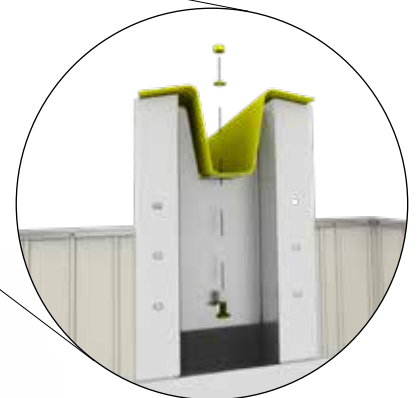
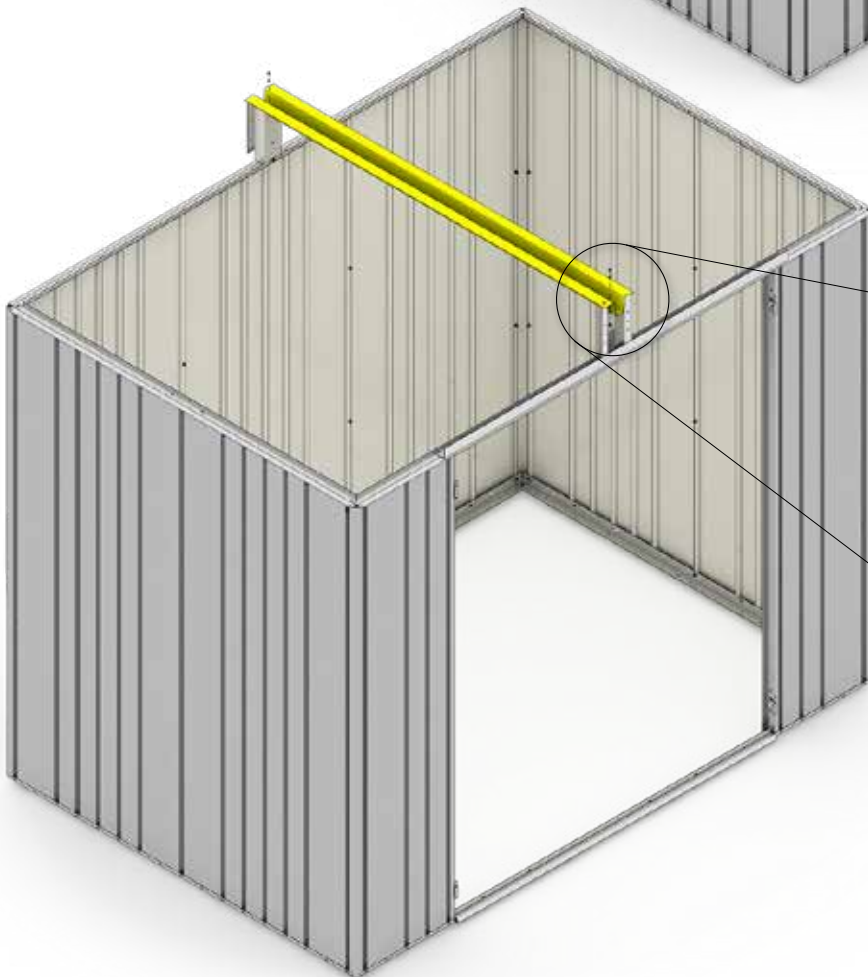
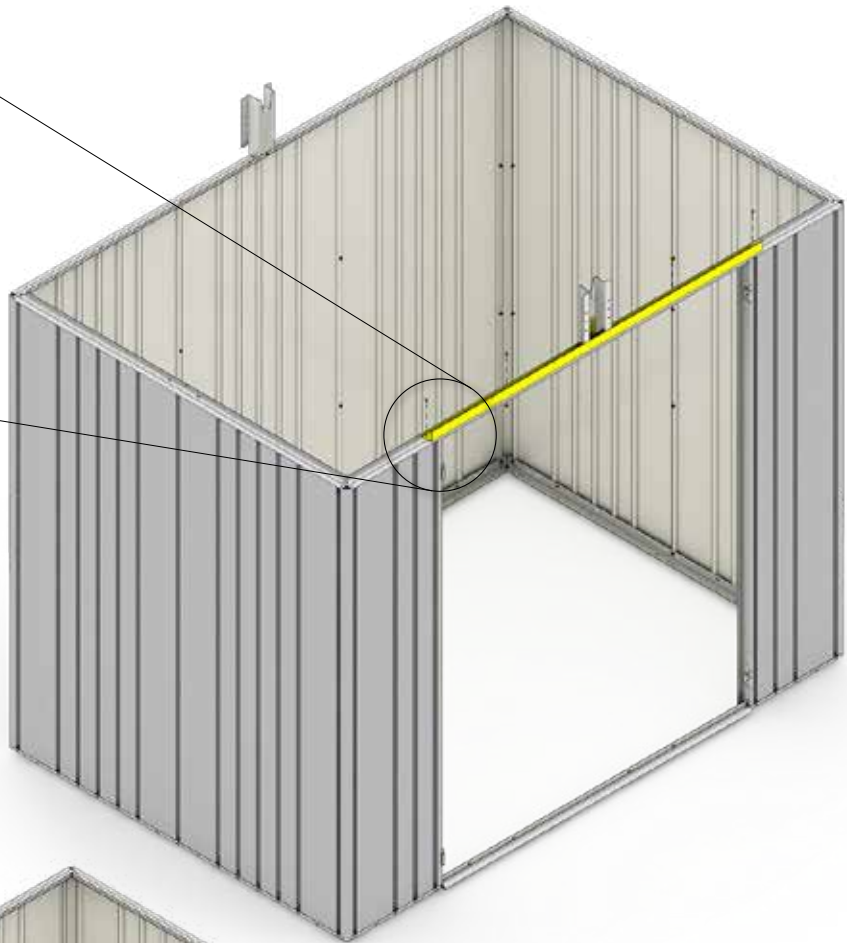

6.

 <p>ⓕ</p>		1: 1x	4A: 1x	 <p>ⓙ3</p>		1: 1x	4A: 1x	<p>M4 x 10</p>  <p>ⓓ2</p>	1: 10x	4A: 10x
		2: 1x	5: 1x			2: 1x	5: 1x		2: 4x	5: 10x
		2A: 1x	6: 1x			2A: 1x	6: 1x		2A: 6x	6: 10x
		3: 1x	7: 1x			3: 1x	7: 1x		3: 6x	7: 10x
4: 1x		4: 1x		4: 6x						



7.

 (AM)	 1: 2x 4A: 2x 2: 2x 5: 2x 2A: 2x 6: 2x 3: 2x 7: 2x 4: 2x	 (AN)	 1: 2x 4A: 2x 2: 2x 5: 2x 2A: 2x 6: 2x 3: 2x 7: 2x 4: 2x	M4 x 10  (D2)	1: 8x 4A: 8x 2: 8x 5: 8x 2A: 8x 6: 8x 3: 8x 7: 8x 4: 8x
---	--	---	--	--	---

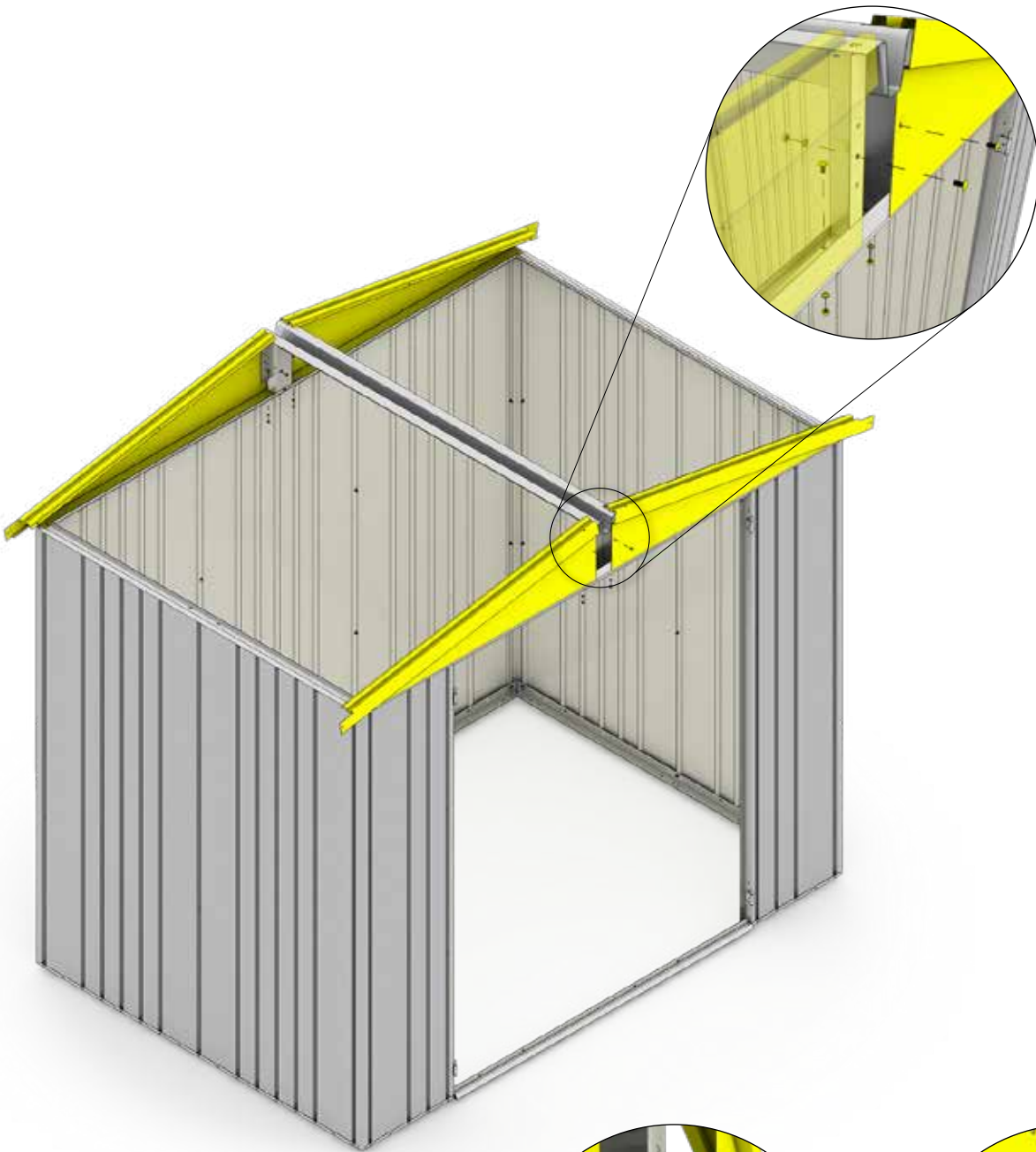

8.



1: 2x 4A: 2x
 2: 2x 5: 2x
 2A: 2x 6: 2x
 3: 2x 7: 2x
 4: 2x

M4 x 10



1: 6x 4A: 8x
 2: 8x 5: 10x
 2A: 6x 6: 12x
 3: 8x 7: 12x
 4: 10x

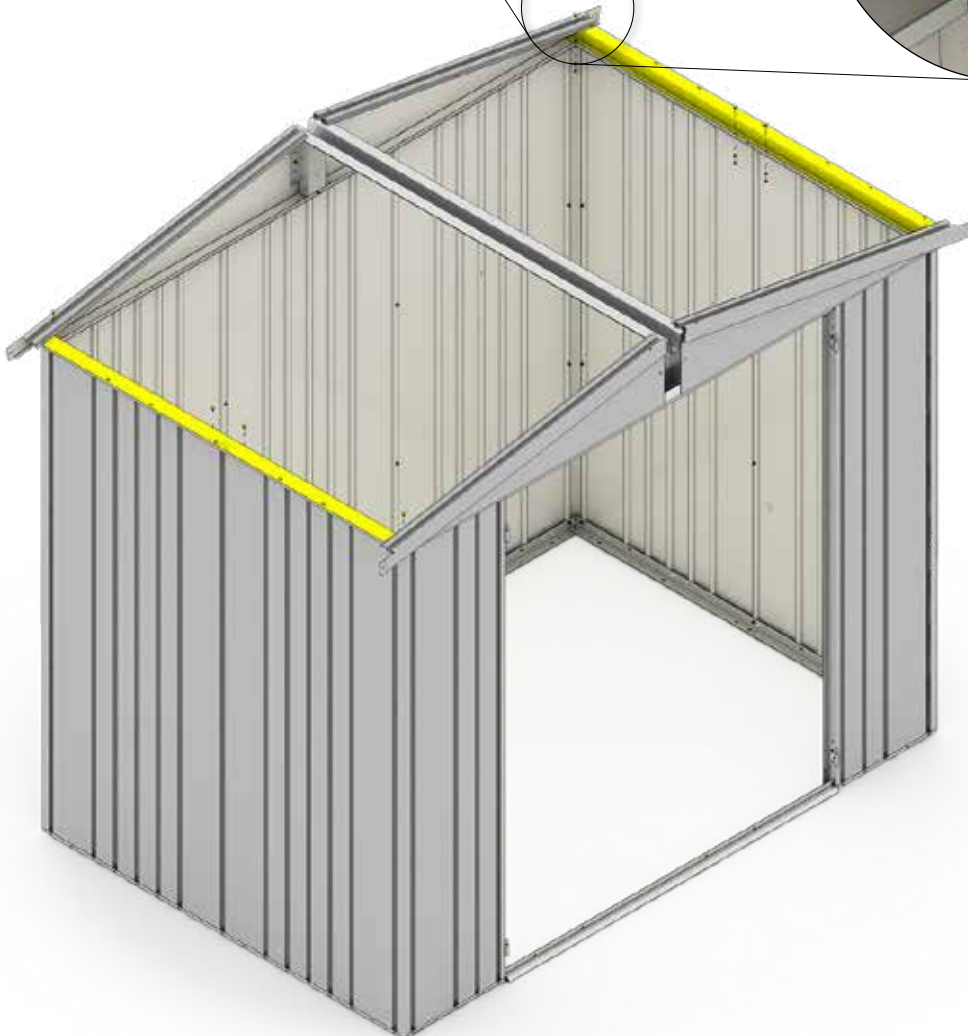
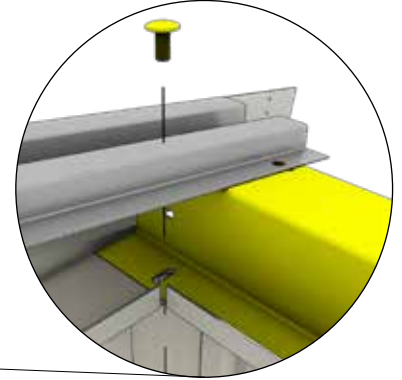
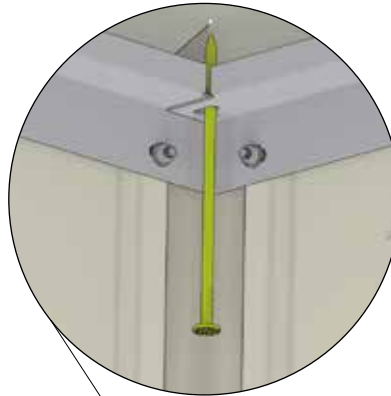

optionales Zubehör - Accessories - Accessoires - Toebehoor - Accessori - Accesorios - Ekstraudstyr



Seitendach | side canopy | auvent

Aufbauanleitung für Seitendach beachten. Muss nur ausgeführt werden, wenn Sie das Zubehör auch bestellt haben.

(GB) Notice assembly manual for side canopy. Only necessary if you have ordered it as accessory.

(F) Instruction de montage pour auvent à suivre. A ne réaliser uniquement si vous avez commandé cet accessoire.

9.

 <p>②</p>		1: 2x 4A: 2x 2: 2x 5: 2x 2A: 2x 6: 2x 3: 2x 7: 2x 4: 2x	M4 x 10  <p>②</p>	1: 4x 4A: 4x 2: 4x 5: 4x 2A: 4x 6: 4x 3: 4x 7: 4x 4: 4x	 <p>①</p>	1: 2x 2: 2x
--	---	---	---	---	--	--------------------

1.



2.

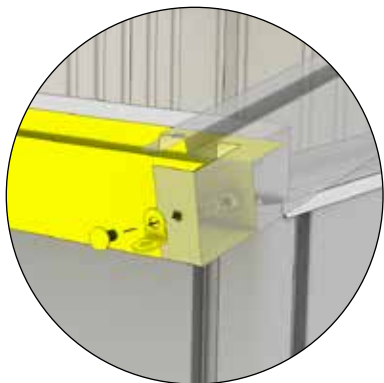
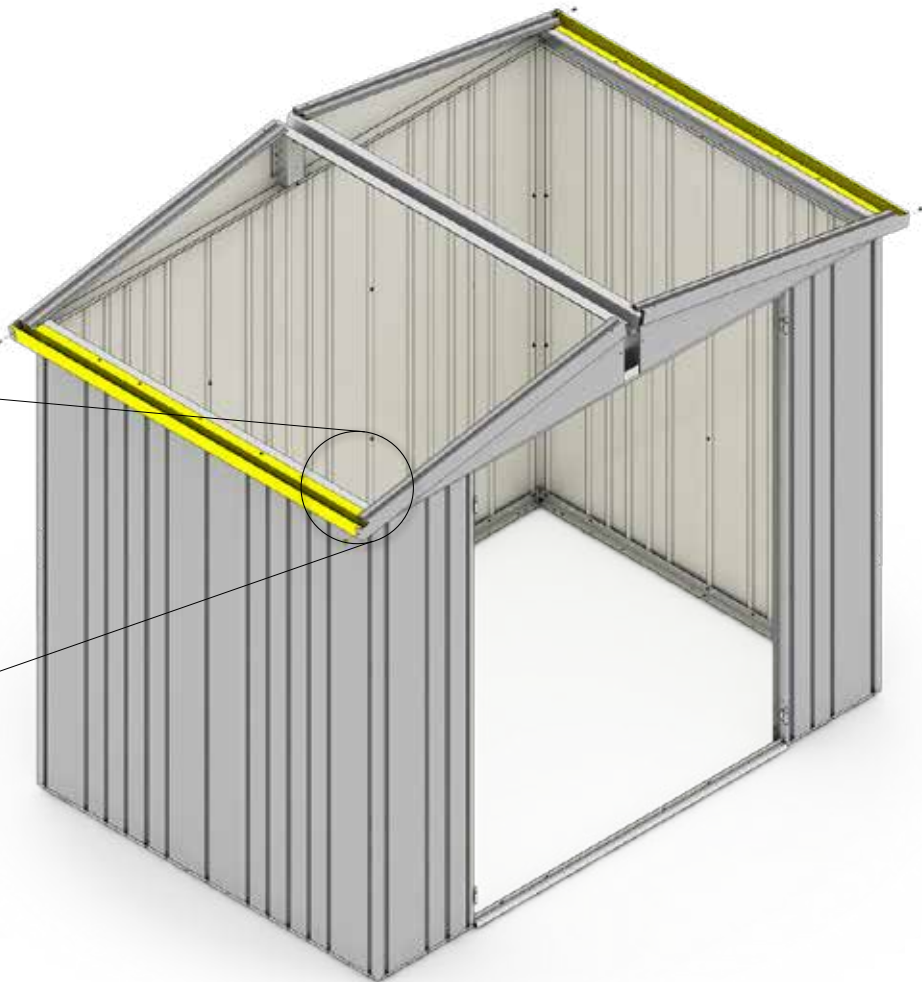
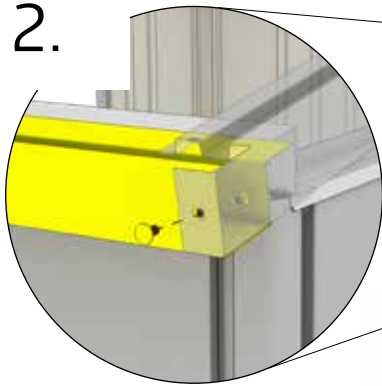

Nur für Größe 1-2!
 Only for size 1-2
 Uniquement pour taille 1-2
 Alleen voor maat 1-2
 Sólo para el tamaño 1-2
 Solo per misura 1-2
 Kun for størrelse 1-2

10.



Ⓢ

- 1: 2x 4A: 4x
- 2: 4x 5: 6x
- 2A: 2x 6: 8x
- 3: 4x 7: 8x
- 4: 6x

M4 x 10



ⓓ2

- 1: 8x 4A: 26x
- 2: 14x 5: 36x
- 2A: 12x 6: 36x
- 3: 20x 7: 46x
- 4: 28x

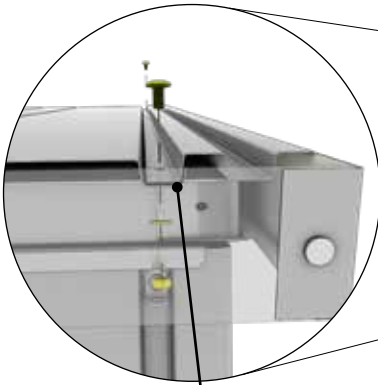
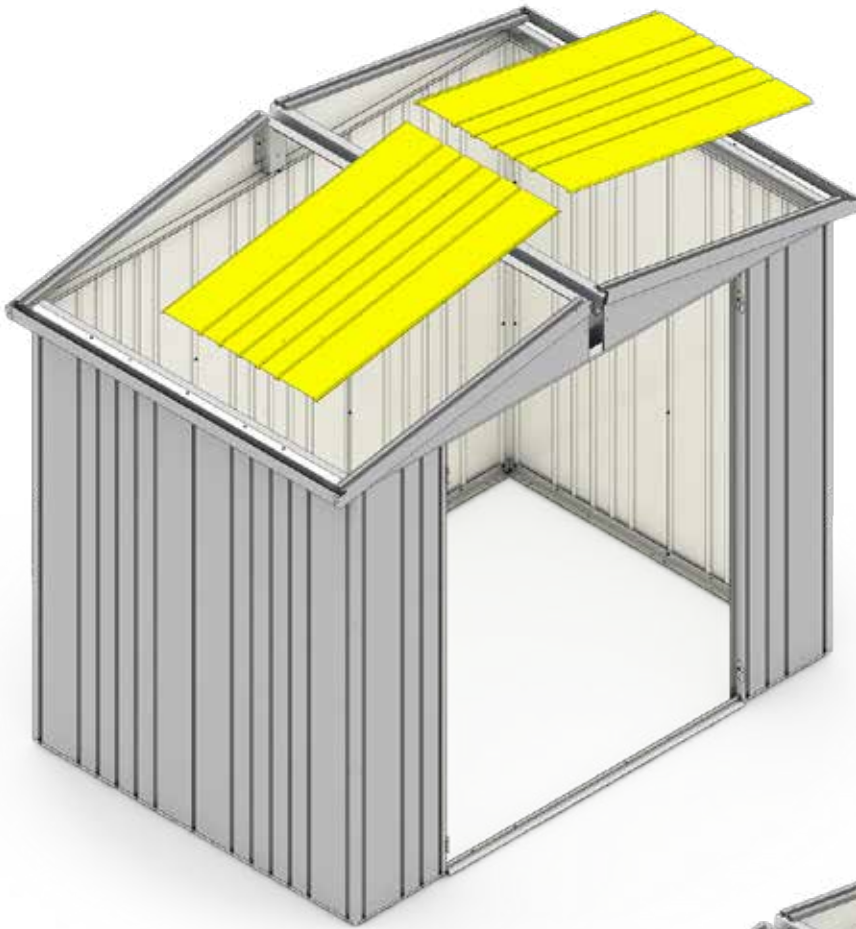

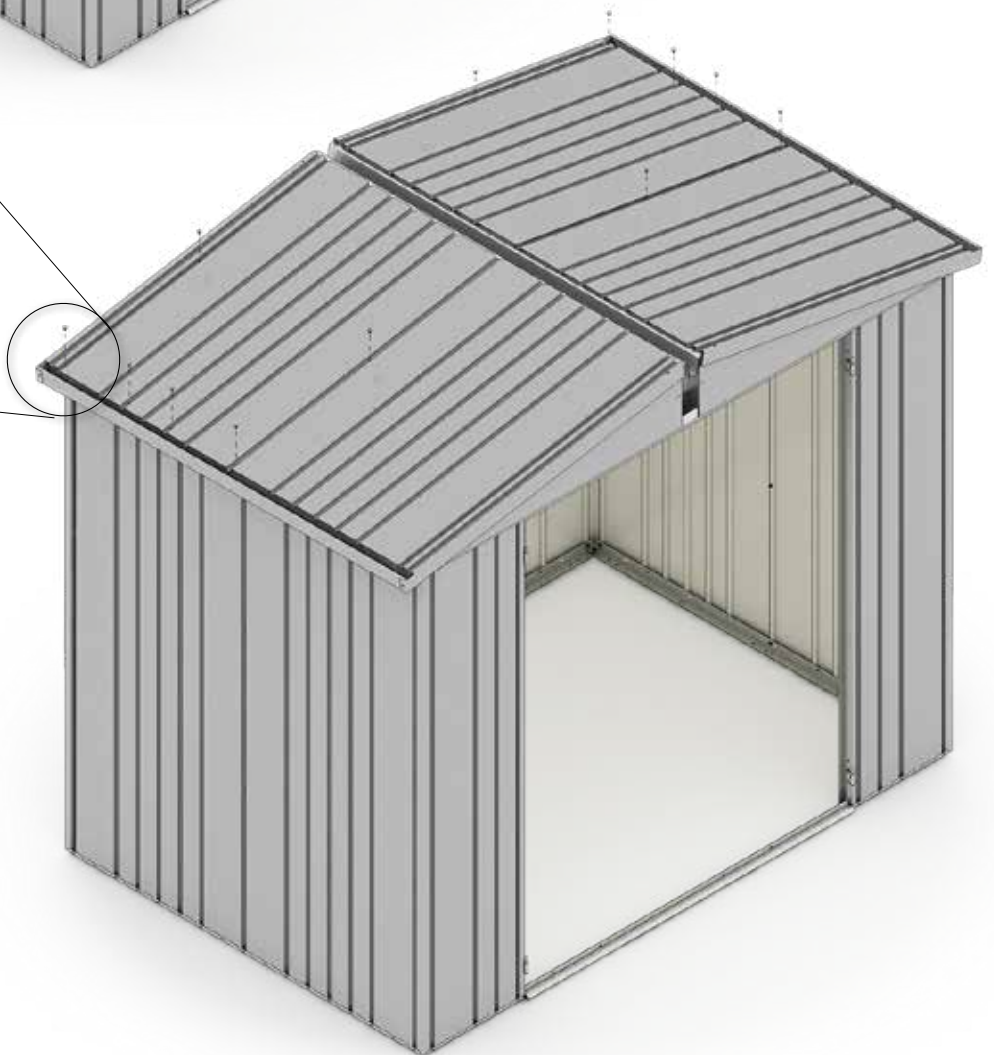
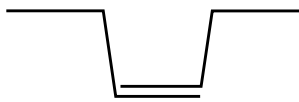
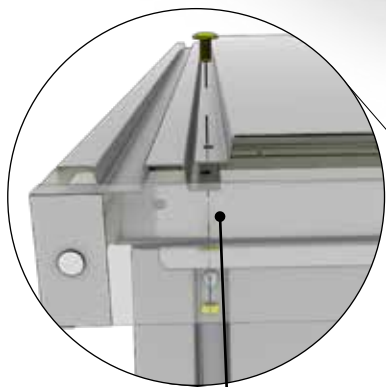
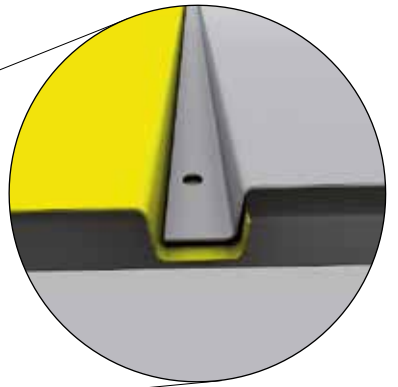
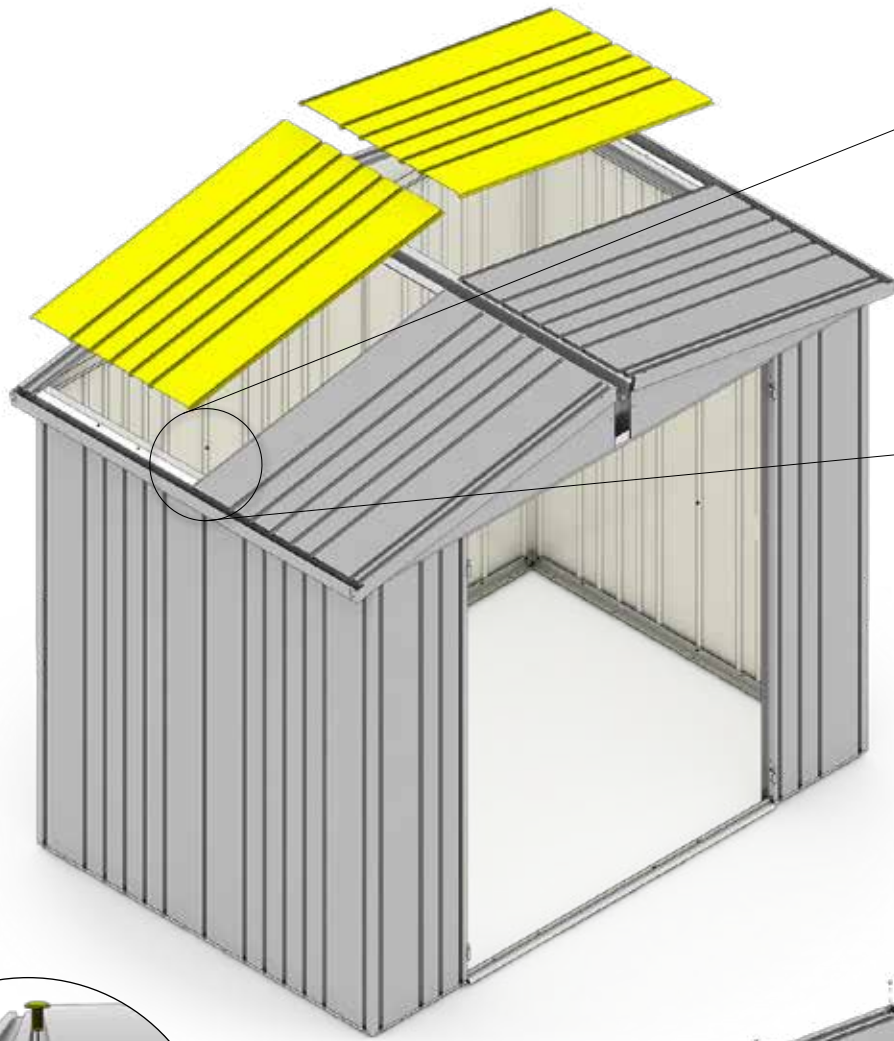

11.

		1: 1x	4A: 1x
		2: 1x	5: 1x
		2A: 1x	6: 1x
		3: 1x	7: 1x
4: 1x			
		1: 1x	4A: 1x
		2: 1x	5: 1x
		2A: 1x	6: 1x
		3: 1x	7: 1x
4: 1x			
		2: 1x	5: 2x
		3: 1x	6: 3x
		4: 2x	7: 3x
		4A: 1x	

1.

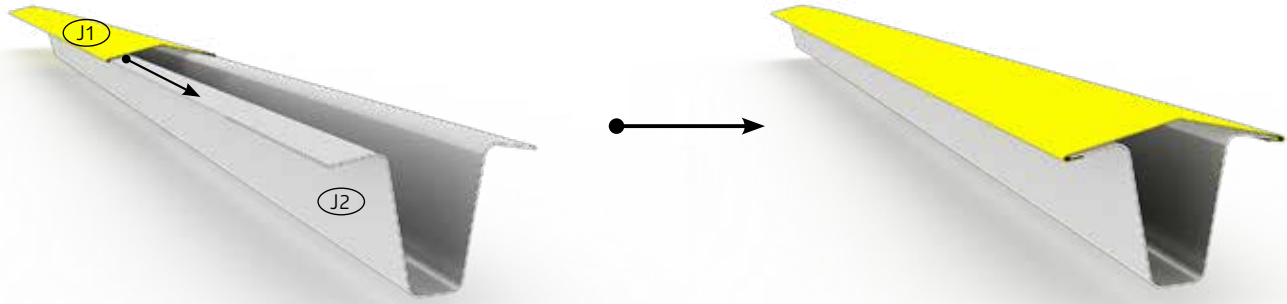

2.

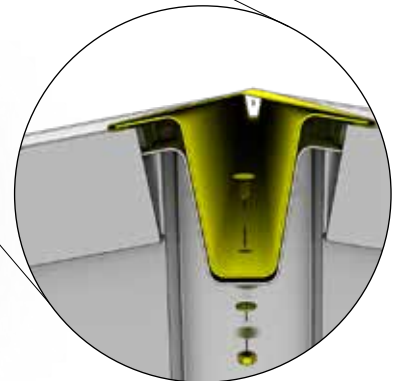
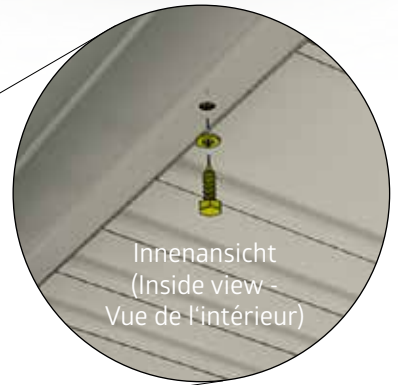
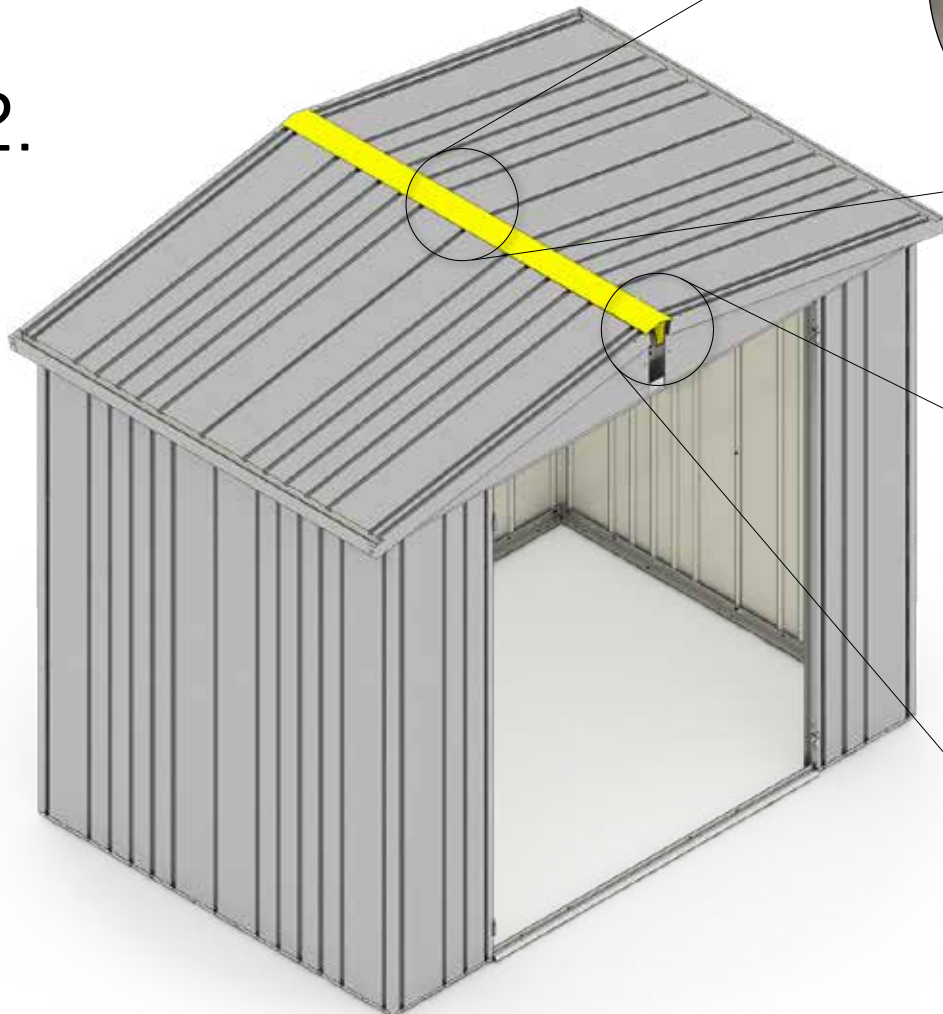

12.



AS

- | | |
|--------|--------|
| 1: 2x | 4A: 2x |
| 2: 2x | 5: 2x |
| 2A: 2x | 6: 2x |
| 3: 2x | 7: 2x |
| 4: 2x | |

M4x10



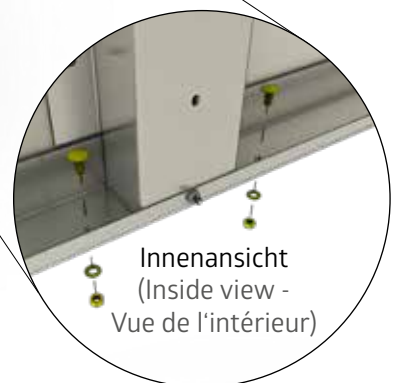
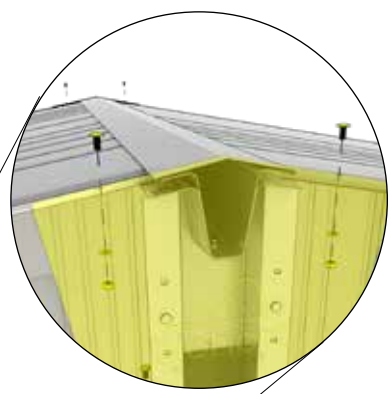
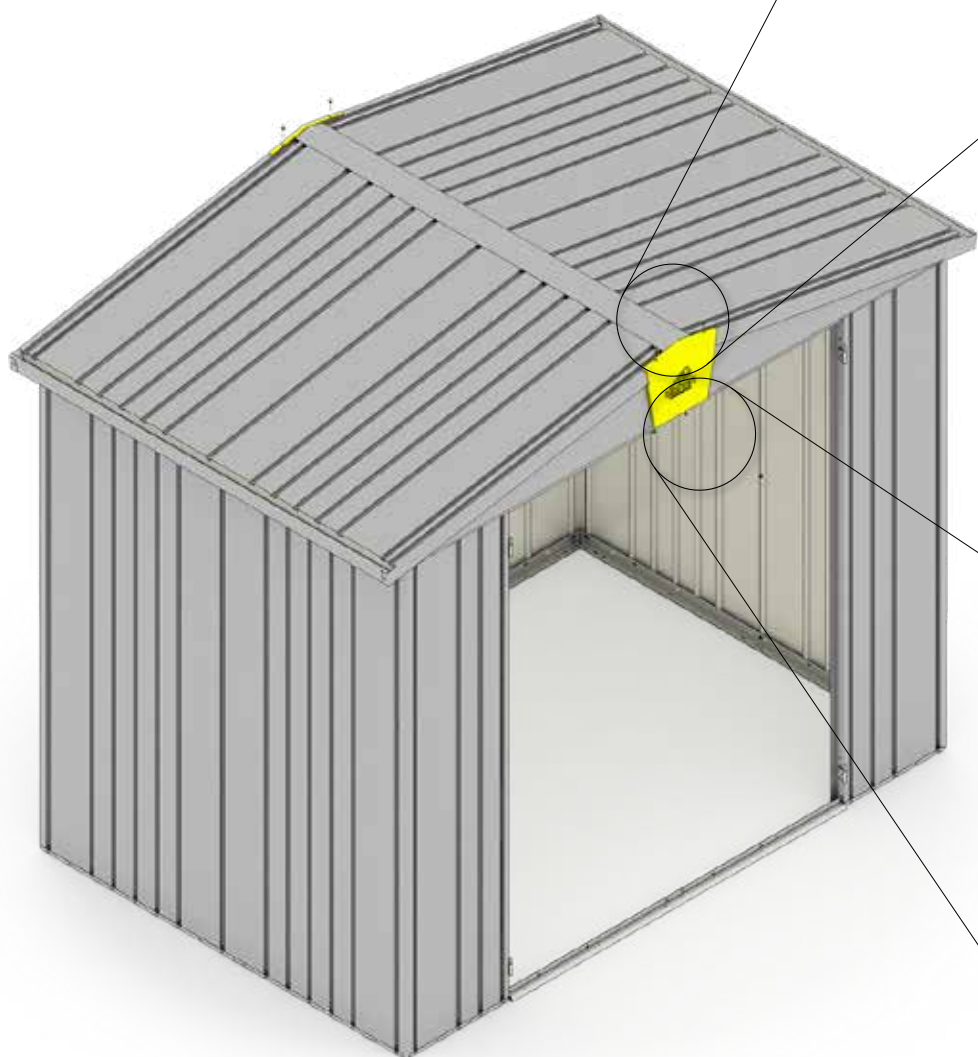

D2

- | | |
|--------|--------|
| 1: 8x | 4A: 8x |
| 2: 8x | 5: 8x |
| 2A: 8x | 6: 8x |
| 3: 8x | 7: 8x |
| 4: 8x | |







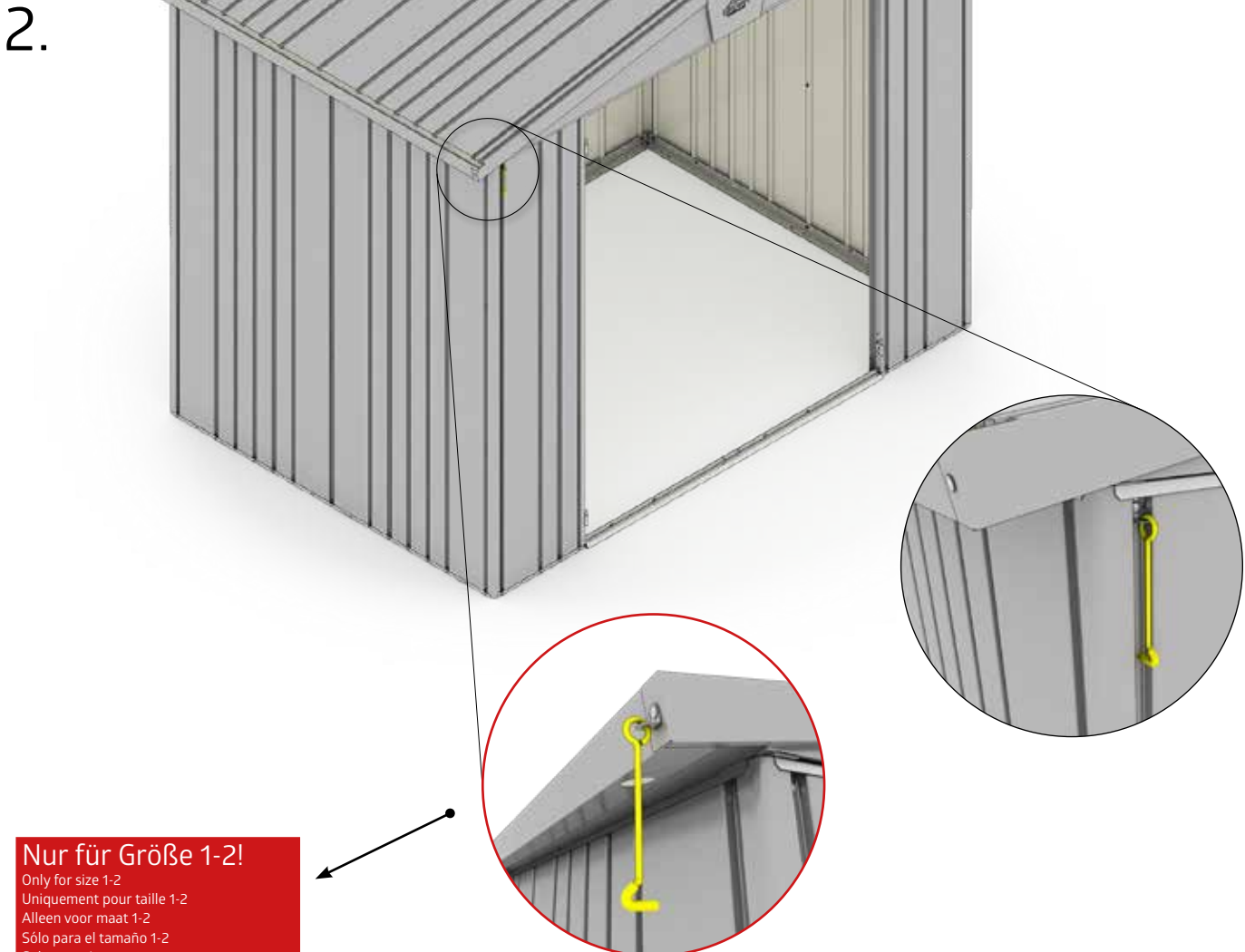



13.

	1: 2x	4A: 2x		1: 2x	4A: 2x
	2: 2x	5: 2x		2: 2x	5: 2x
	2A: 2x	6: 2x		2A: 2x	6: 2x
	3: 2x	7: 2x		3: 2x	7: 2x
	4: 2x			4: 2x	



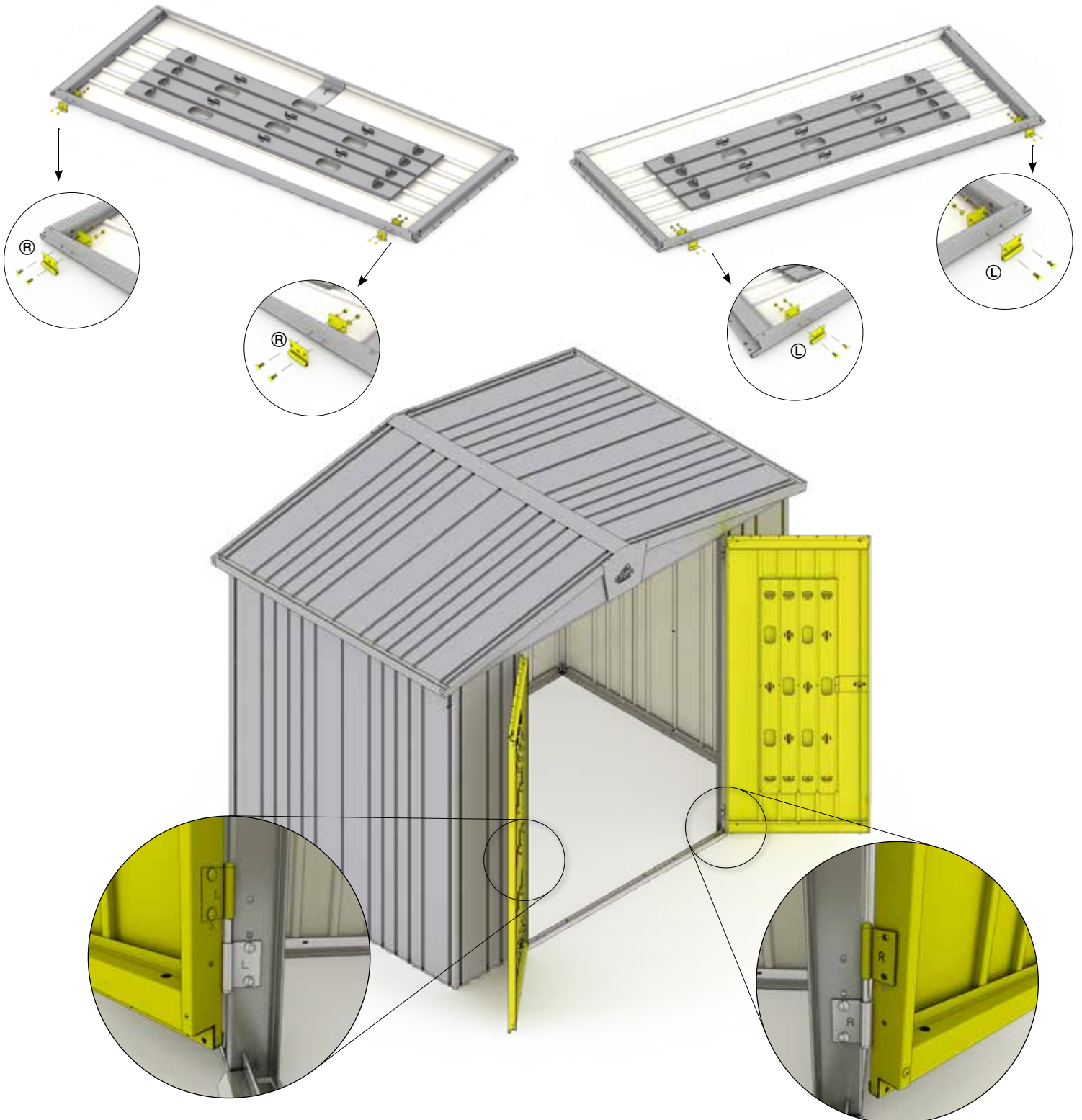

14.

 <p>Ⓜ</p> <p>Ⓜ1</p>	<p>1: 2x 4A: 2x 2: 2x 5: 2x 2A: 2x 6: 2x 3: 2x 7: 2x 4: 2x</p>	 <p>Ⓛ</p> <p>Ⓛ1</p>	<p>1: 2x 4A: 2x 2: 2x 5: 2x 2A: 2x 6: 2x 3: 2x 7: 2x 4: 2x</p>	 <p>Ⓜ1</p>	<p>1: 4x 4A: 4x 2: 4x 5: 4x 2A: 4x 6: 4x 3: 4x 7: 4x 4: 4x</p>
 <p>Ⓜ</p>	 <p>ⓁA</p>	 <p>ⓁA</p>	<p>M4 x 10</p>  <p>Ⓜ2</p>	 <p>Ⓜ2</p>	<p>1: 8x 4A: 8x 2: 8x 5: 8x 2A: 8x 6: 8x 3: 8x 7: 8x 4: 8x</p>







15.

 (D1)	1: 2x	4A: 2x
	2: 2x	5: 2x
	2A: 2x	6: 2x
	3: 2x	7: 2x
4: 2x		
 (D1)	1: 4x	4A: 4x
	2: 4x	5: 4x
	2A: 4x	6: 4x
	3: 4x	7: 4x
4: 4x		

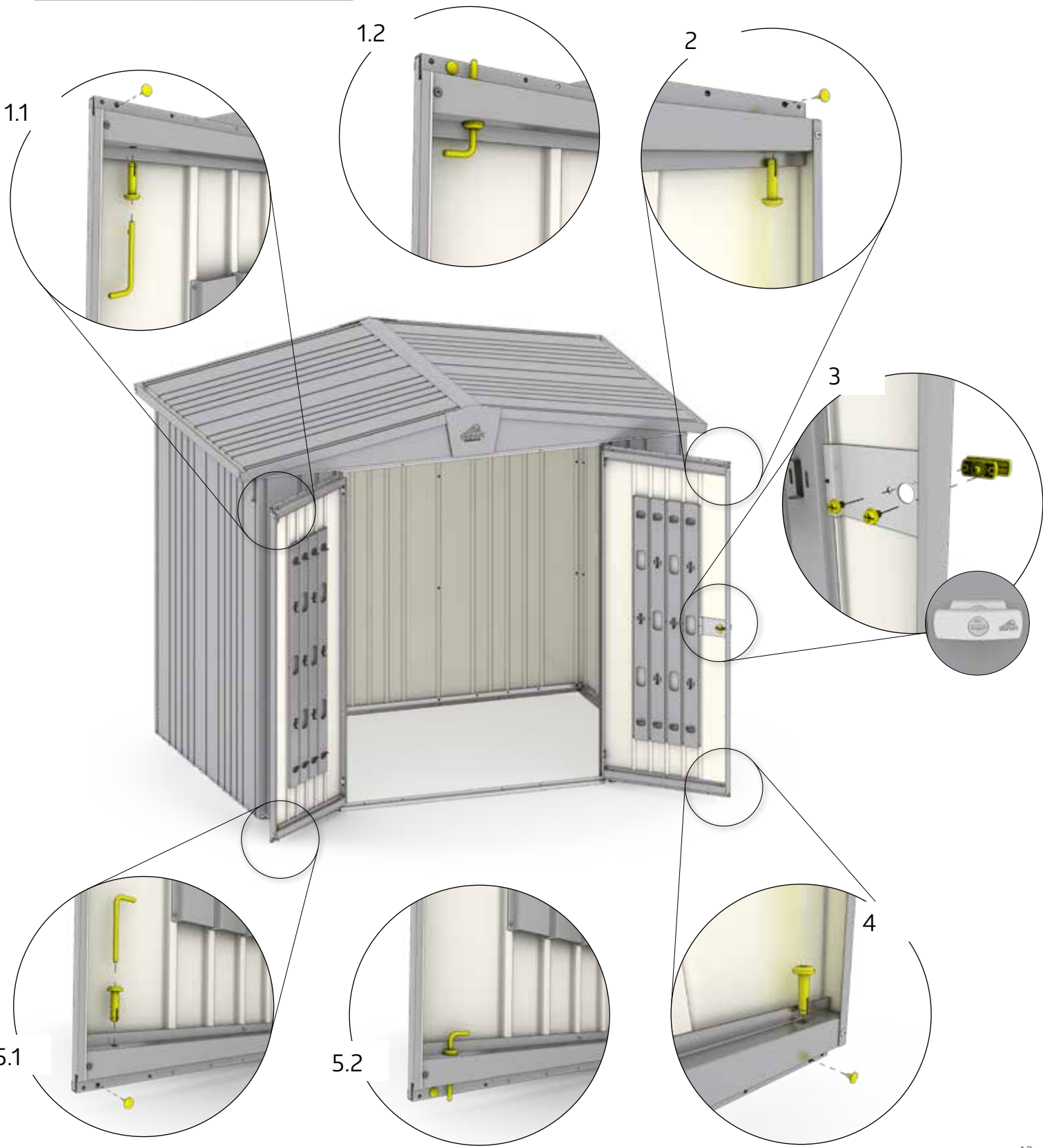
 (D1)	1: 4x	4A: 4x
	2: 4x	5: 4x
	2A: 4x	6: 4x
	3: 4x	7: 4x
4: 4x		

 (D1)	1: 1x	4A: 1x
	2: 1x	5: 1x
	2A: 1x	6: 1x
	3: 1x	7: 1x
4: 1x		



 U	1: 2x 4A: 2x	 D1	1: 1x 4A: 1x	 D1	1: 1x 4A: 1x
	2: 2x 5: 2x		2: 1x 5: 1x		2: 1x 5: 1x
	2A: 2x 6: 2x		2A: 1x 6: 1x		2A: 1x 6: 1x
	3: 2x 7: 2x		3: 1x 7: 1x		3: 1x 7: 1x
	4: 2x		4: 1		4: 1x



Jährlich ölen!

- Ⓒ Lubricate annually
- Ⓕ Huiler chaque année
- Ⓖ Jaarliks oliën
- Ⓔ Engrasar 1 vez al año
- Ⓙ Lubrificare una volta all'anno
- Ⓚ Smøres årligt!

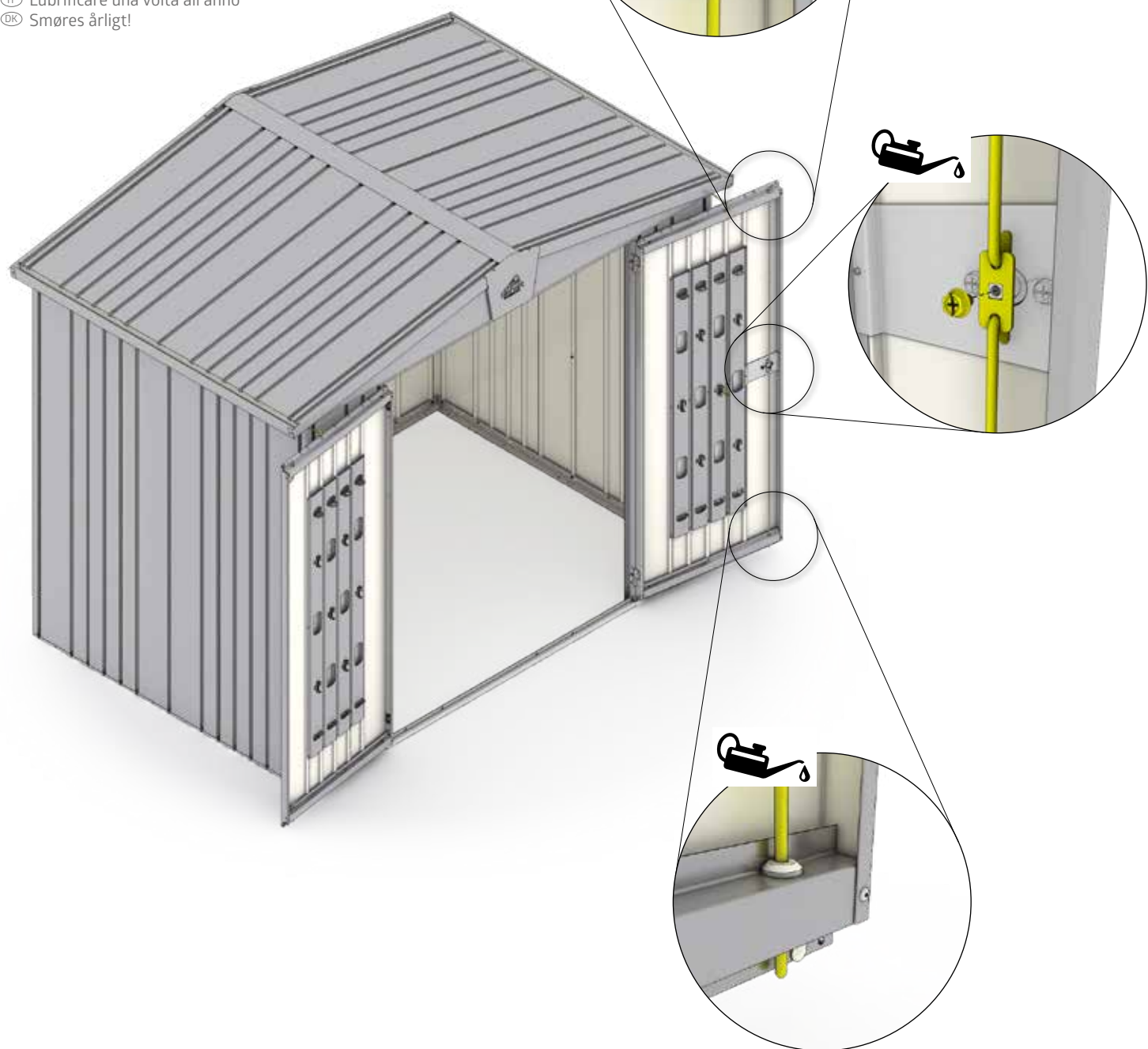

16.



1: 2x 4A: 2x
2: 2x 5: 2x
2A: 2x 6: 2x
3: 2x 7: 2x
4: 2x



1: 2x 4A: 2x
2: 2x 5: 2x
2A: 2x 6: 2x
3: 2x 7: 2x
4: 2x

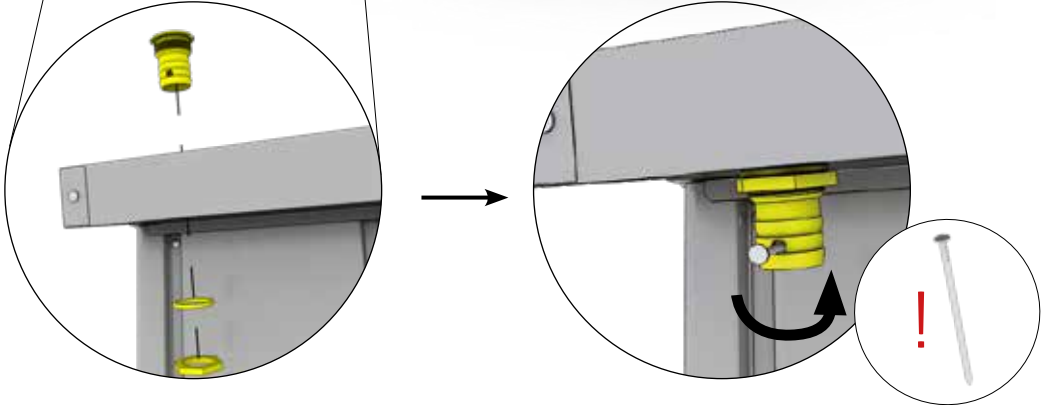
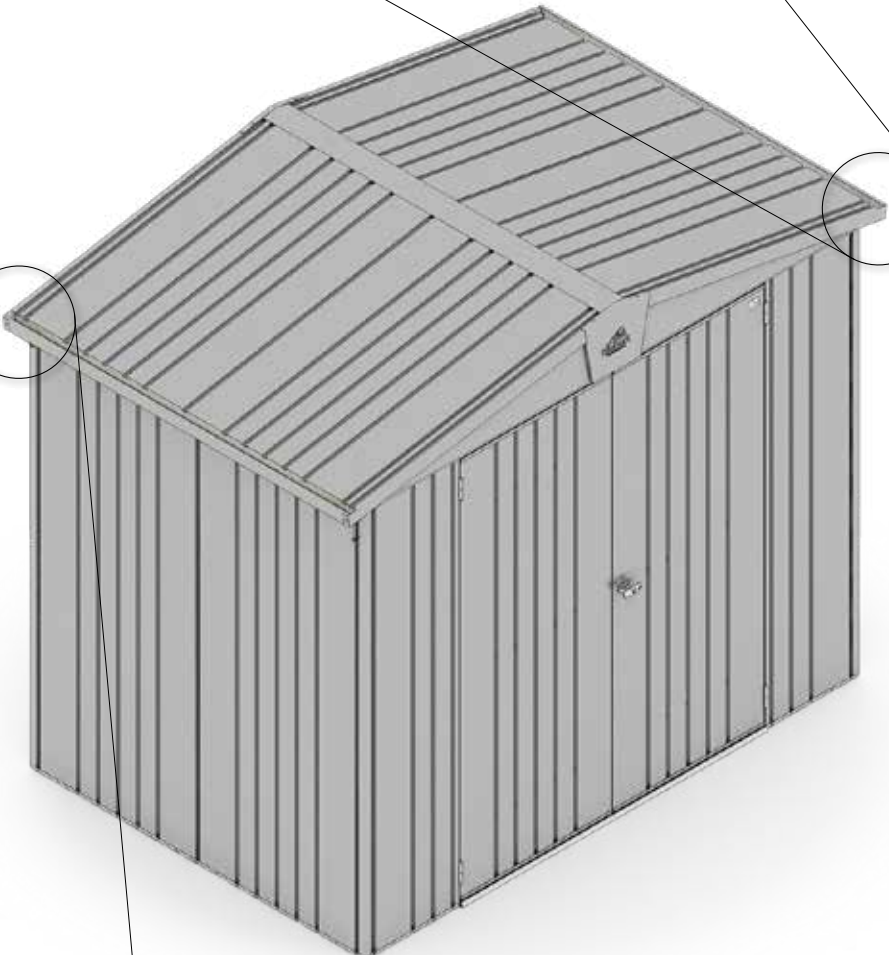
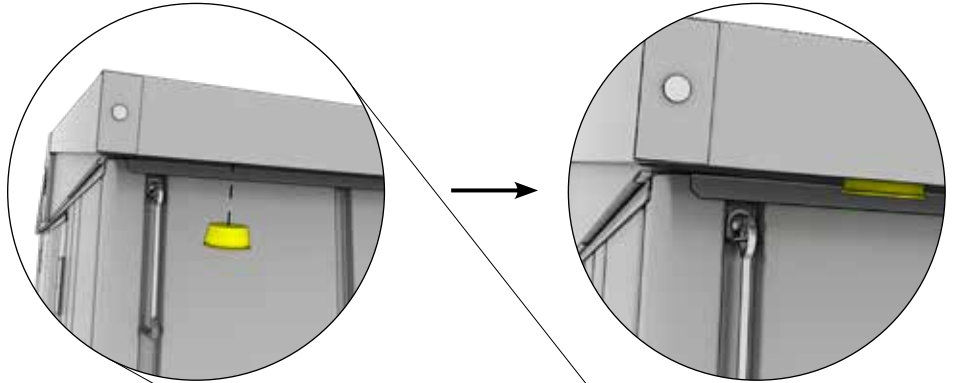

17.



- 1: 1x 4A: 1x
- 2: 1x 5: 1x
- 2A: 1x 6: 1x
- 3: 1x 7: 1x
- 4: 1x

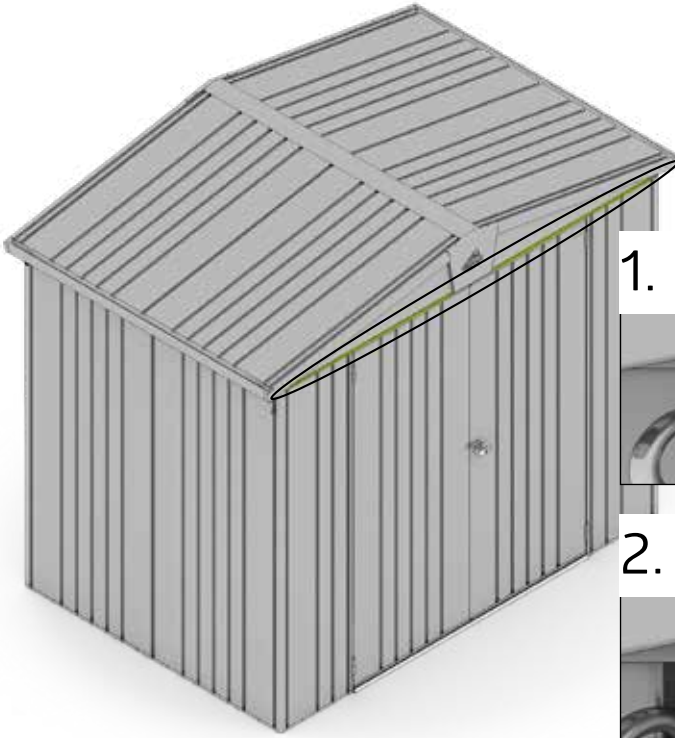

18.

Tür einrichten

- GB align the door
- FR ajuster la porte
- NL deur afstellen
- ES ajuste la puerta
- IT aggiustare la porta
- DK justering af dør

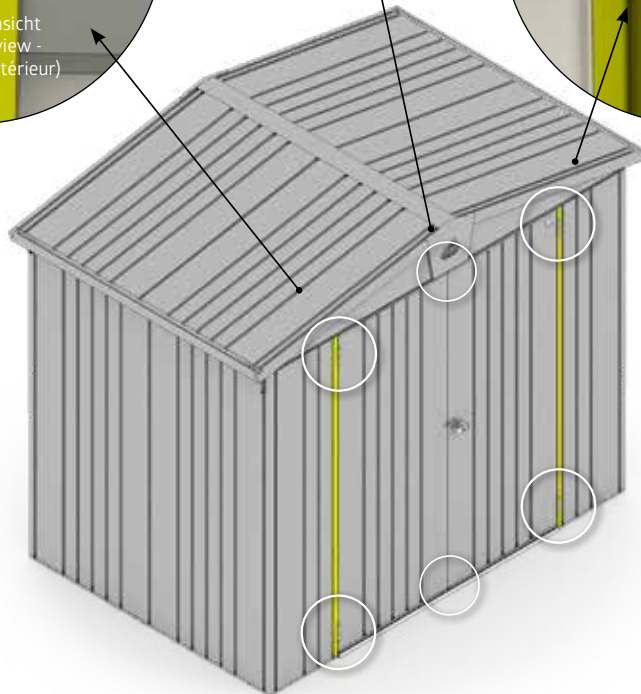
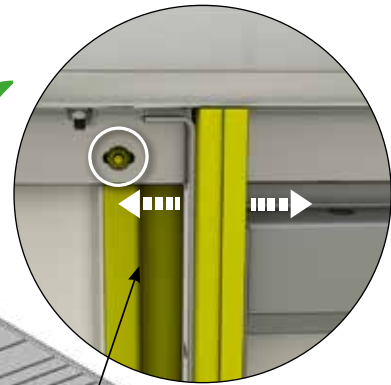
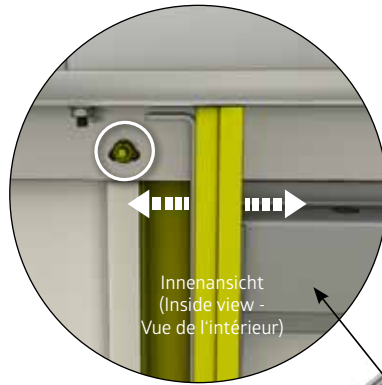

 (D1)	1: 4x	4A: 4x
	2: 4x	5: 4x
	2A: 4x	6: 4x
	3: 4x	7: 4x
	4: 4x	

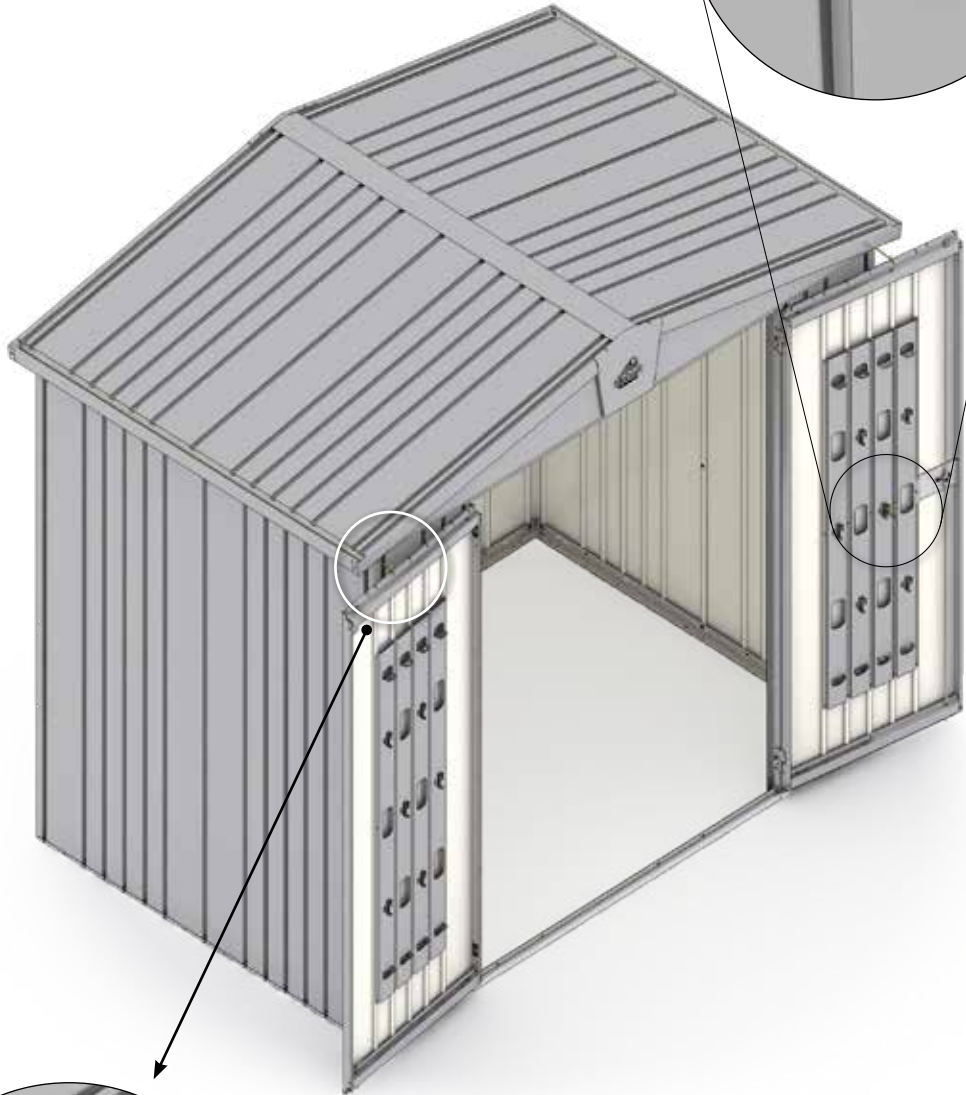

Funktion Windhaken

function of the door hooks, fonction des crochets de porte

19.



D2

- 1: 6x 4A: 6x
- 2: 6x 5: 6x
- 2A: 6x 6: 6x
- 3: 6x 7: 6x
- 4: 6x

Rechtwinkelig einrichten

- GB rectangular adjusted
- FR ajuster en forme rectangulaire
- NL rechthoekig instellen
- ES ajustar en forma rectangular
- IT mettere in forma rettangolare
- DK indstil vinkelret

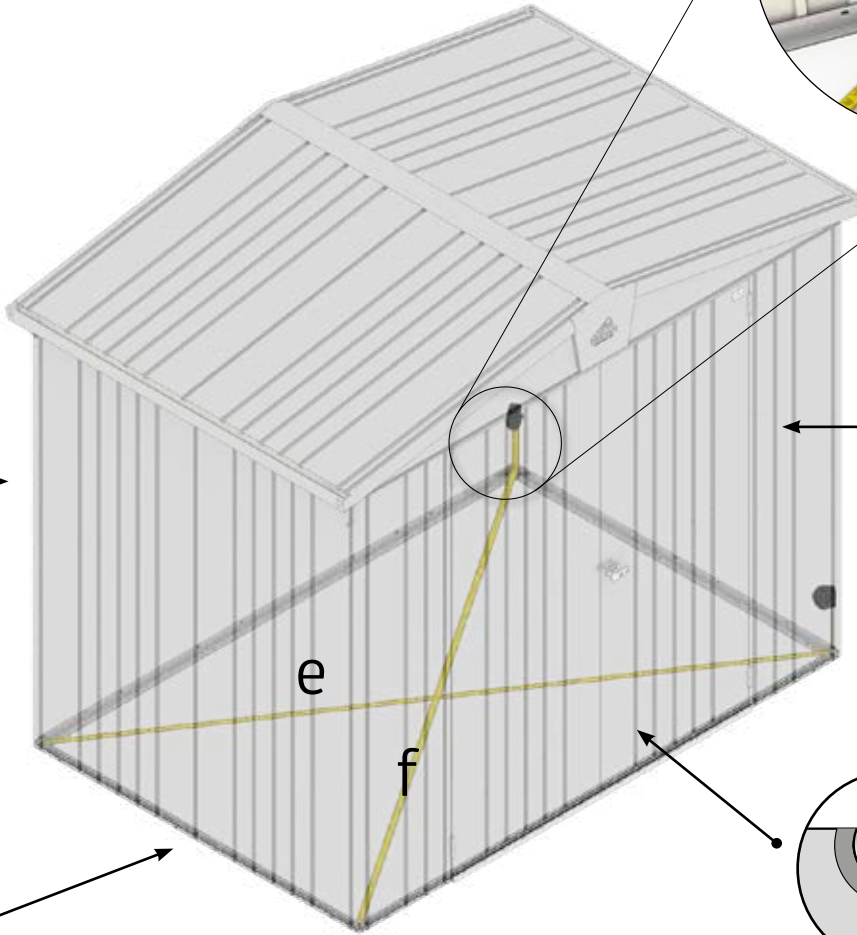
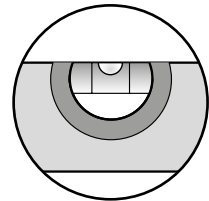
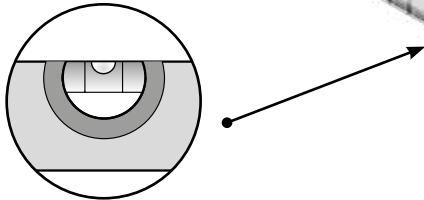
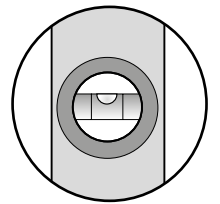
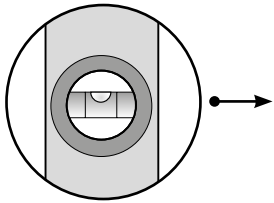

$e = f$



Ziehen Sie jetzt alle Schraubverbindungen fest an!

Tighten now all nuts and connections securely! - Serrez maintenant les vis à fond! - Draai nu alle schroeven vast! - Ahora puede apretar y fijar todos los tornillos y tuercas - Adesso serrare a fondo tutti i dadi - Fastspænd nu alle bolt-/skruerforbindelser!





Bodenrahmen

Floor Frame - Cadre de sol - Bodemframe - Marco de suelo - Telaio perimetrale - Bundramme

Variante 1, Proposal 1, Variant 1

		1: 4x	4A: 8x
		2: 6x	5: 10x
		2A: 6x	6: 10x
		3: 8x	7: 10x
		4: 8x	

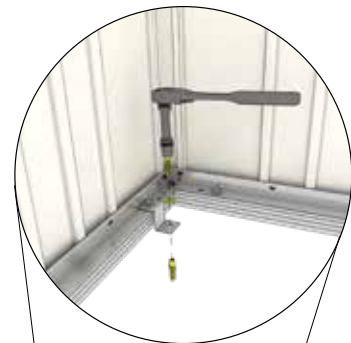
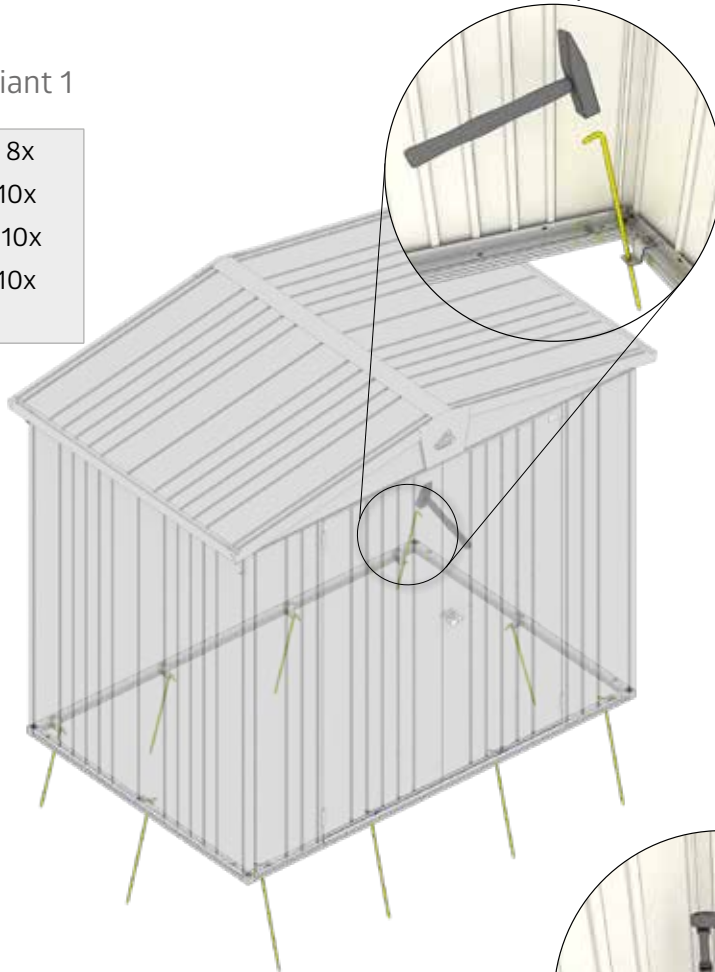
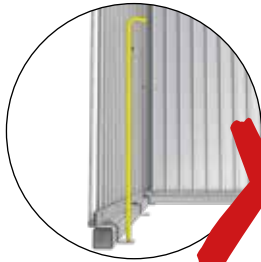

Variante 2, Proposal 2, Variant 2

	1: 8x	4A: 8x
	2: 8x	5: 8x
	2A: 8x	6: 8x
	3: 8x	7: 10x
	4: 8x	

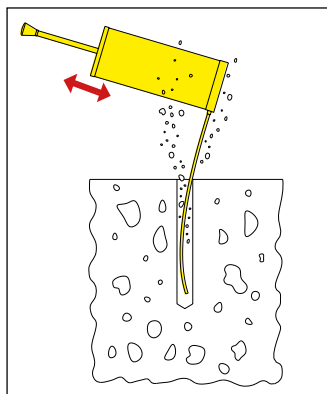
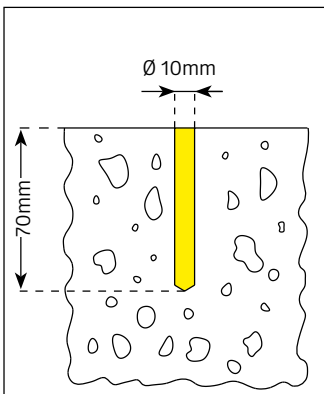
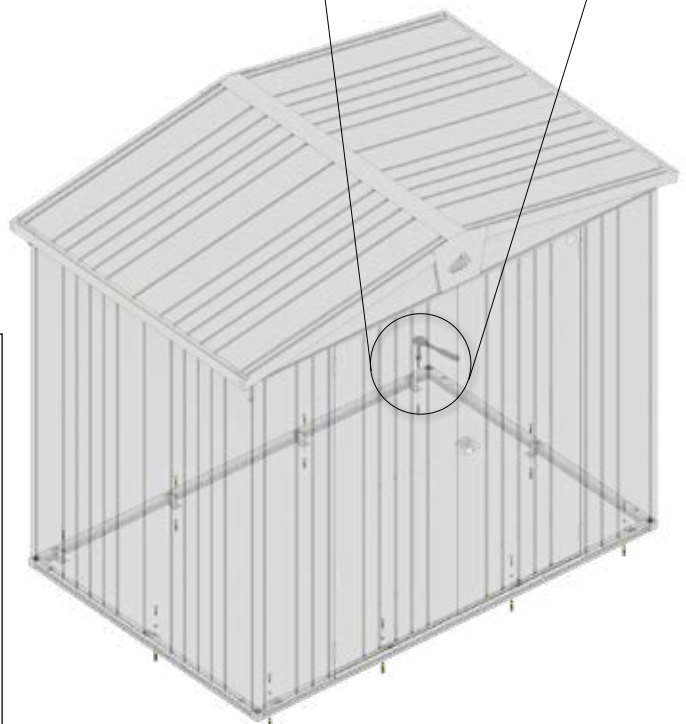

8 x 60 D1	1: 8x	4A: 8x
	2: 8x	5: 8x
	2A: 8x	6: 8x
	3: 8x	7: 8x
	4: 8x	

Variante 3, Proposal 3, Variant 3

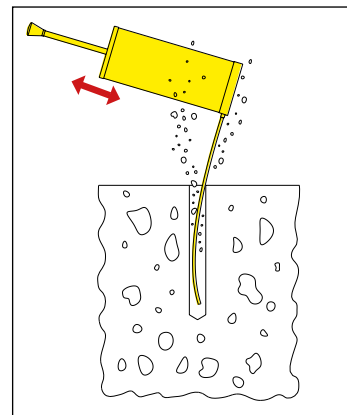
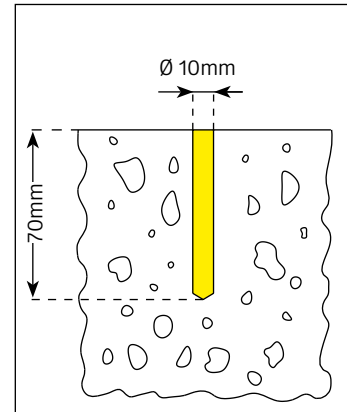
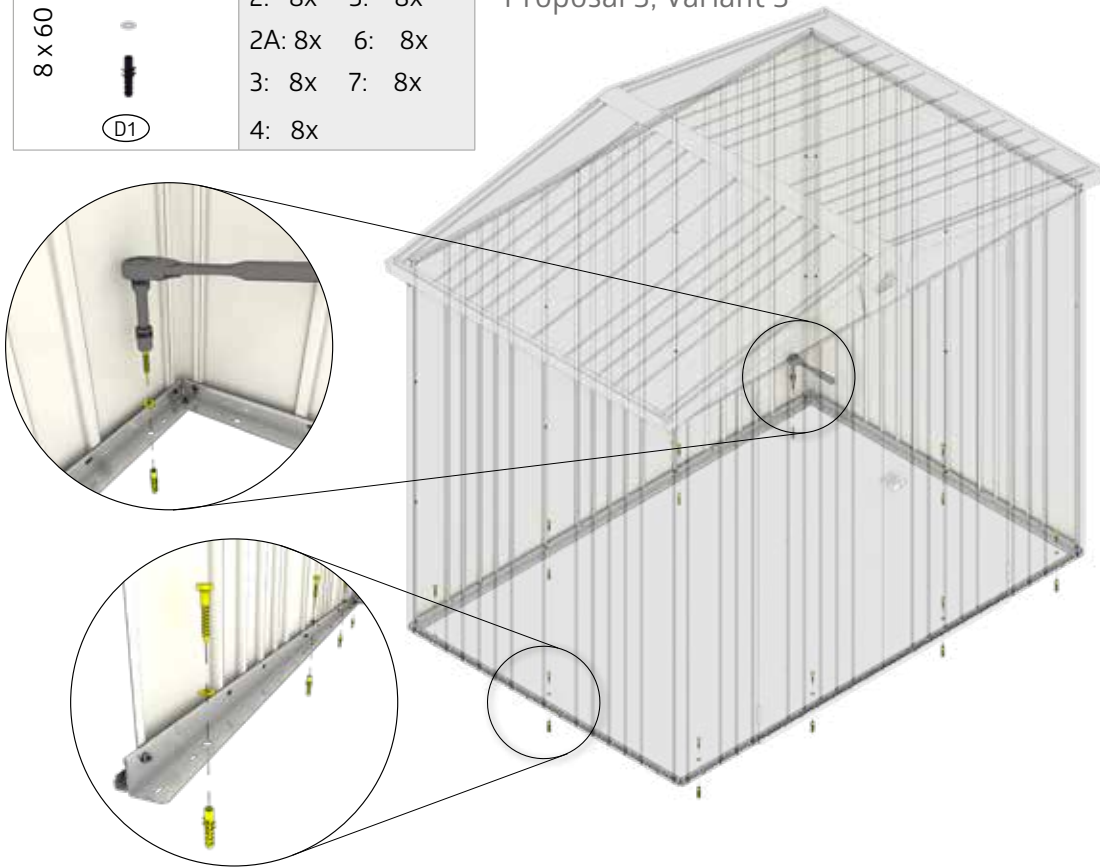

Größenabhängiger Montageschritt - Size-Dependent assembly step - Dépendant de la taille - Size-Dependent montagestep

Nur für Größe 2A und 4A

Only for size 2A and 4A - Uniquement pour taille 2A et 4A - Alleen voor maat 2A en 4A - Sólo para los tamaños 2A y 4A - Solo per misura 2A e 4A - Kun for størrelse 2A og 4A

	2A: 2x
	4A: 2x

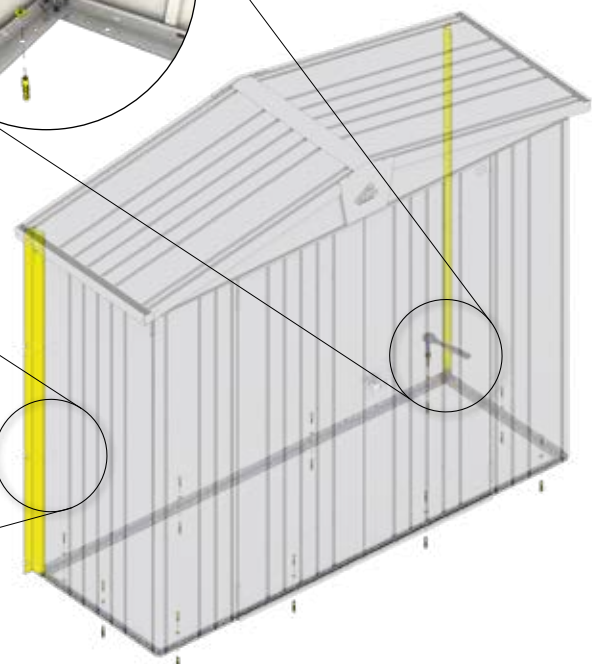
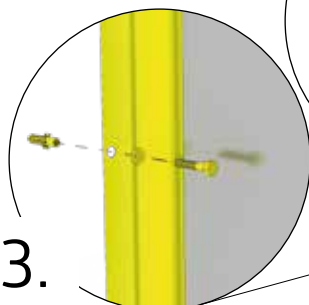
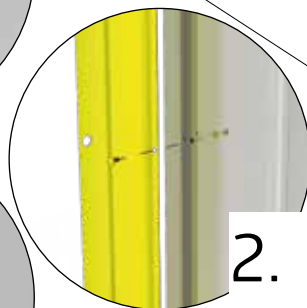
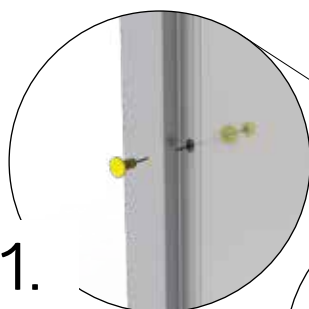

Paso de montaje de tamaño Dependiente - Taglia-Dependent fase di montaggio - Størrelses-anhængig montage skridt

20.

 **3**

1: 2x	4A: 2x
2: 2x	5: 2x
2A: 2x	6: 2x
3: 2x	7: 2x
4: 2x	

®

 **3**

1: 2x	4A: 2x
2: 2x	5: 2x
2A: 2x	6: 2x
3: 2x	7: 2x
4: 2x	

(AK)

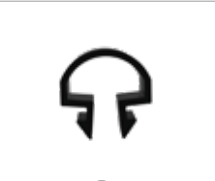
 **D1**

1: 4x	4A: 4x
2: 4x	5: 4x
2A: 4x	6: 4x
3: 4x	7: 4x
4: 4x	

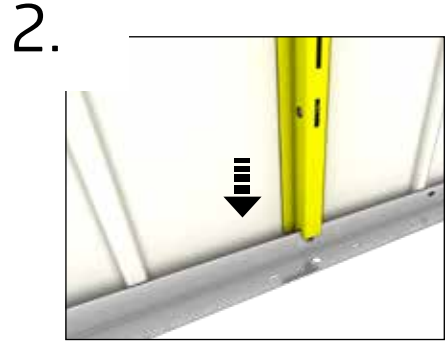
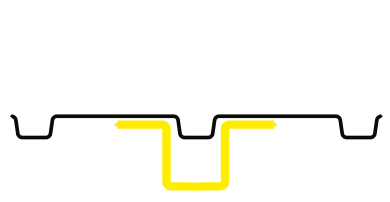

Option 1:



Option 2:

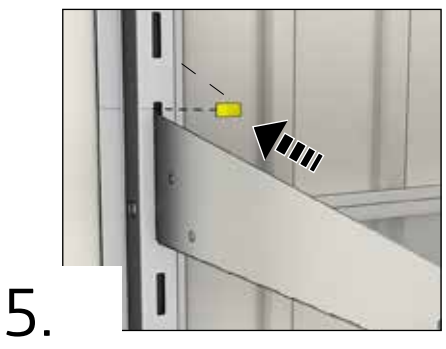
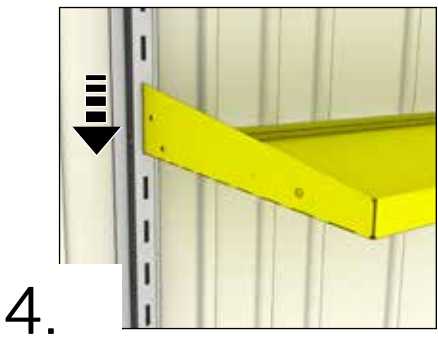
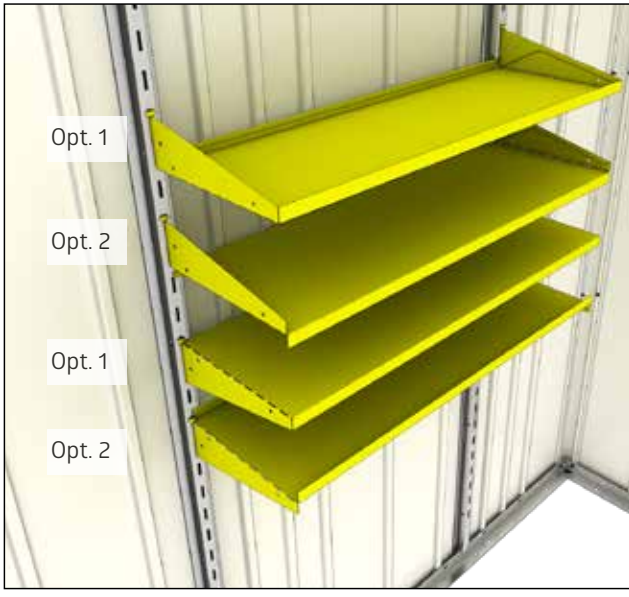

21.

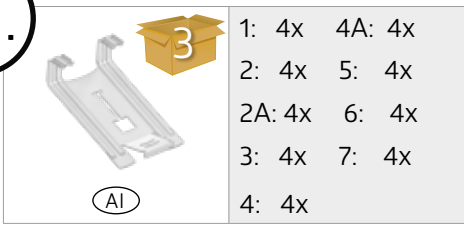

1: 4x 4A: 4x
2: 4x 5: 4x
2A: 4x 6: 4x
3: 4x 7: 4x
4: 4x

(Al)

3

The diagram shows a grey metal bracket with a central slot and two side flaps. A small orange box with the number '3' is positioned above the bracket. Below the bracket is a small circle containing the letters 'Al'.

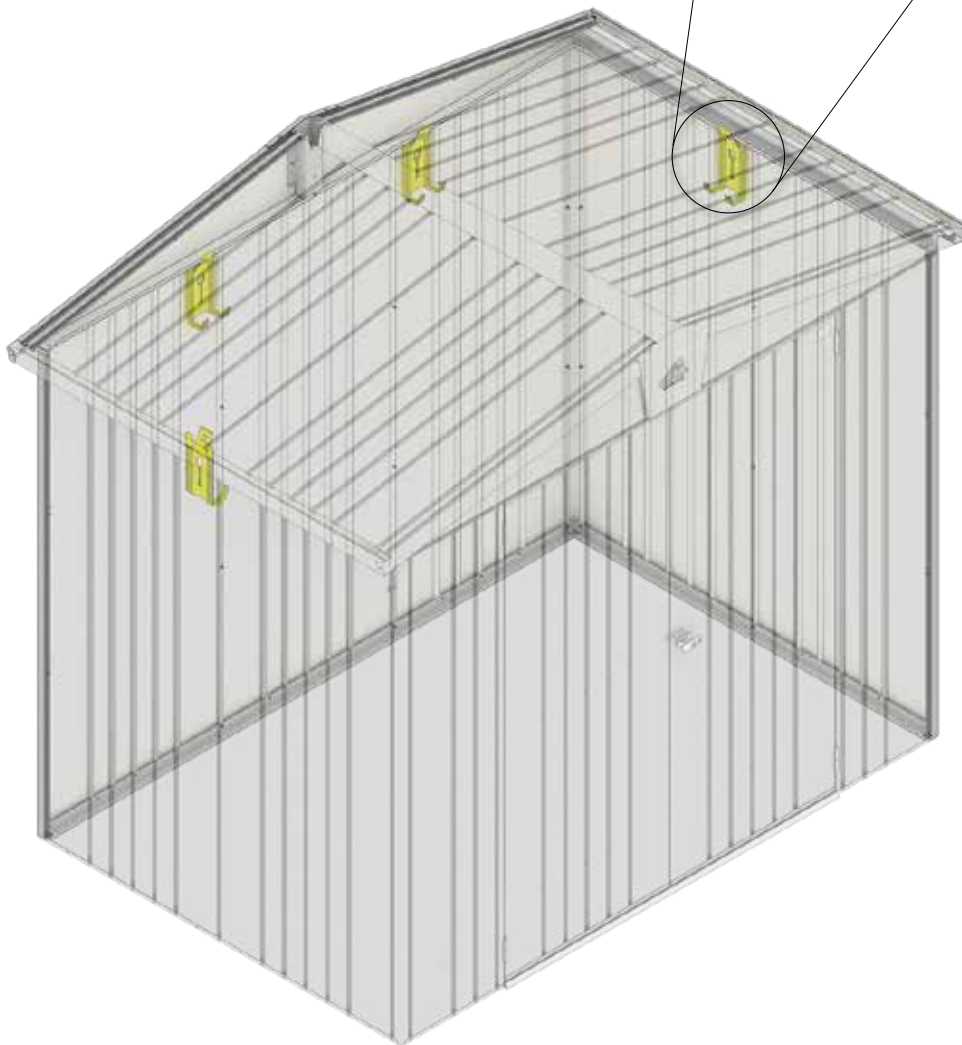
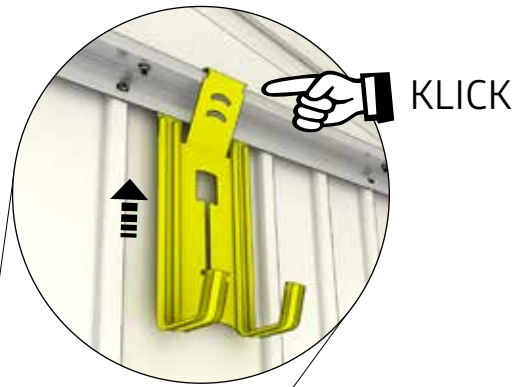



Regenfallrohr

Rain water downpipe - Descente d'eaux pluviales - Regenpijpsset - Set di tubi pluviali - Set de bajante - Tagnedløb

	1: 2x	4A: 2x	M4 x 10		1: 4x	4A: 4x
	2: 2x	5: 2x			2: 4x	5: 4x
	2A: 2x	6: 2x			2A: 4x	6: 4x
	3: 2x	7: 2x			3: 4x	7: 4x
	4: 2x				4: 4x	

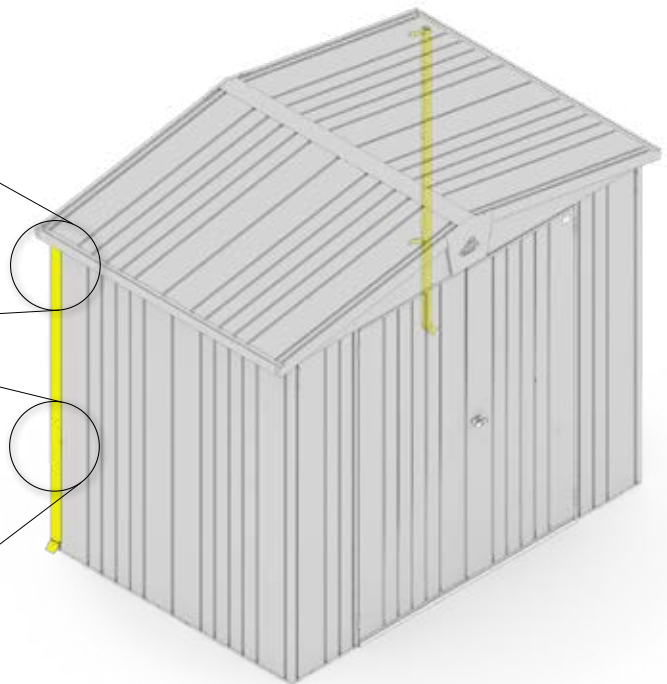

	1: 4x	4A: 4x	M4 x 10		1: 8x	4A: 8x		1: 2x	4A: 2x
	2: 4x	5: 4x			2: 8x	5: 8x		2: 2x	5: 2x
	2A: 4x	6: 4x			2A: 8x	6: 8x		2A: 2x	6: 2x
	3: 4x	7: 4x			3: 8x	7: 8x		3: 2x	7: 2x
	4: 4x				4: 8x			4: 2x	

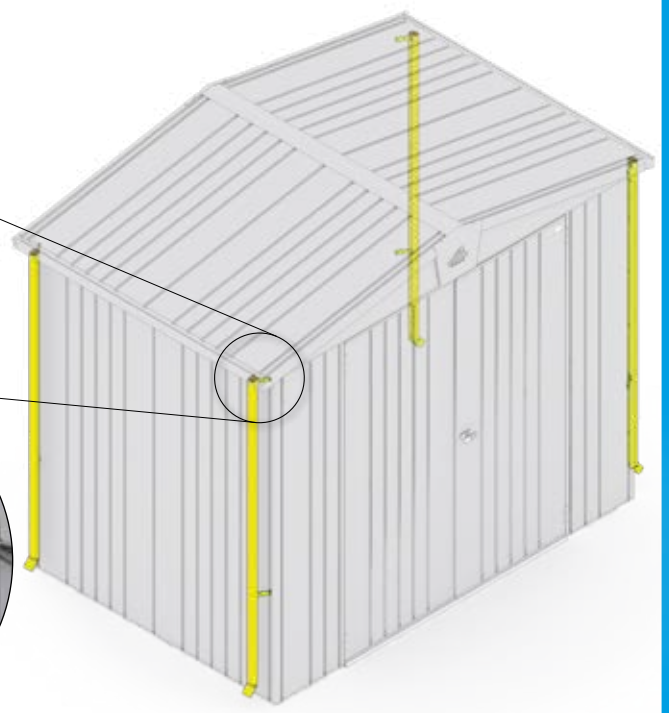
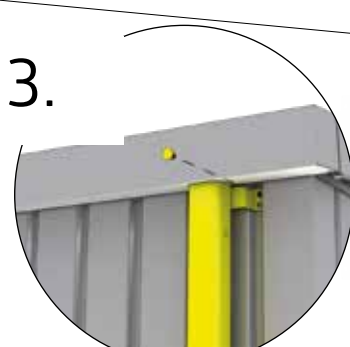
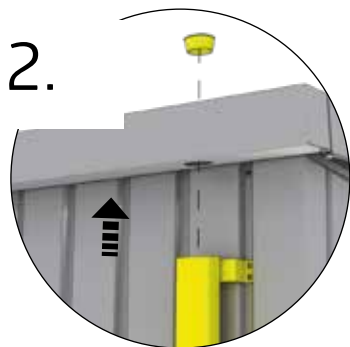
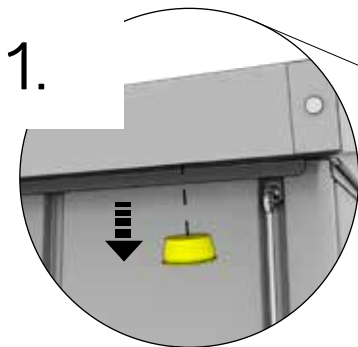



Bodenplatte

Floor Panels - Plaque de fond - Bodemlaaat - Placa de suelo - Pavimentazione - Bundplade

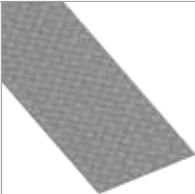
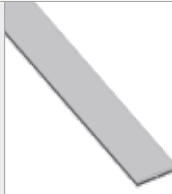
	1: 4x	4A: 8x		1: 1x	4A: 4x		2: 1x	5: 3x
	2: 6x	5: 10x		2: 2x	5: 4x		3: 1x	6: 3x
	2A: 6x	6: 10x		2A: 1x	6: 4x		4: 2x	7: 3x
	3: 8x	7: 13x		3: 2x	7: 4x		4A: 3x	
	4: 8x			4: 3x				

Unterbau für Bodenplatten mit XPS-Platten (2cm od. 3cm)

(nicht im Lieferumfang)

- Ⓒ Substructure of the floor panels with XPS-boards (2 cm | 3 cm) (not included in the scope of delivery)
- Ⓕ Les plaques XPS (2 cm | 3 cm) pour les plaques de fond ne sont pas fournies.
- Ⓖ De XPS- platen (2cm | 3 cm) die onder de bodemlaaat komen, zijn bij de levering niet inbegrepen.
- Ⓔ Las placas de poliestireno extruido XPS (2cm o 3 cm de altura) sobre las que se coloca la placa de suelo no forman parte del suministro.
- Ⓙ Placche XPS (2cm | 3 cm) per basamento di una pavimentazione in alluminio (on fornite in dotazione).
- Ⓚ Underlæg for bundplader med XPS-plader (2 cm eller 3 cm) , (følger ikke med)

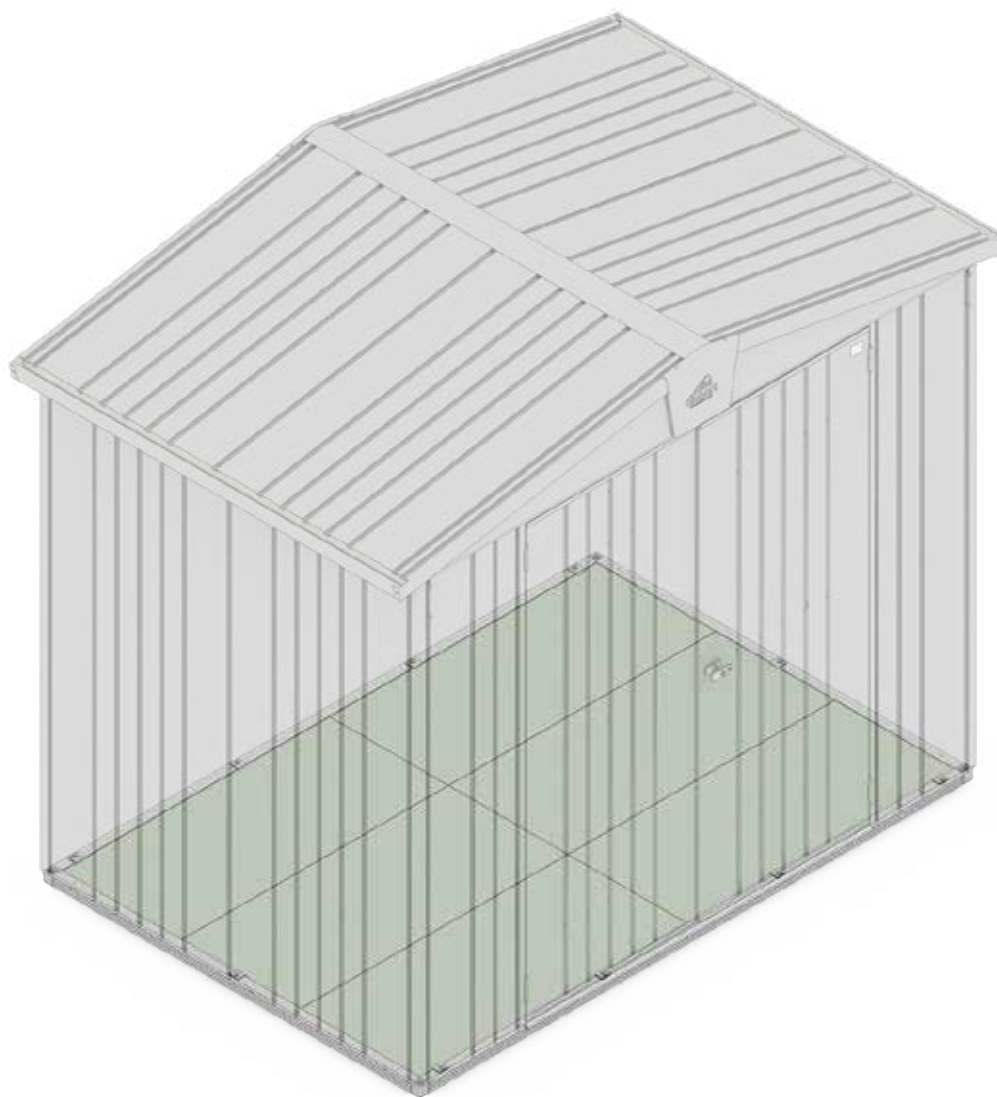

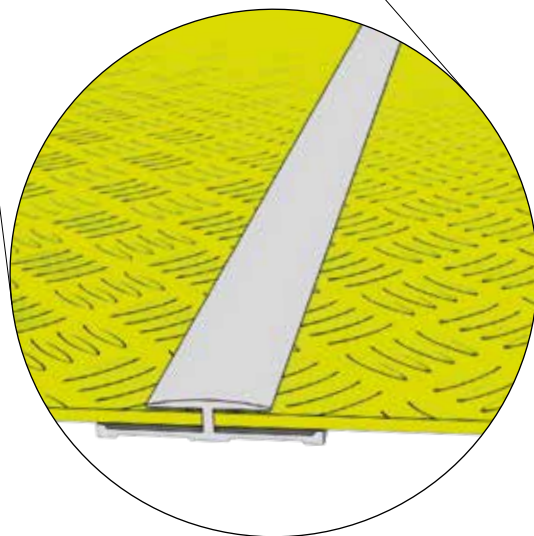
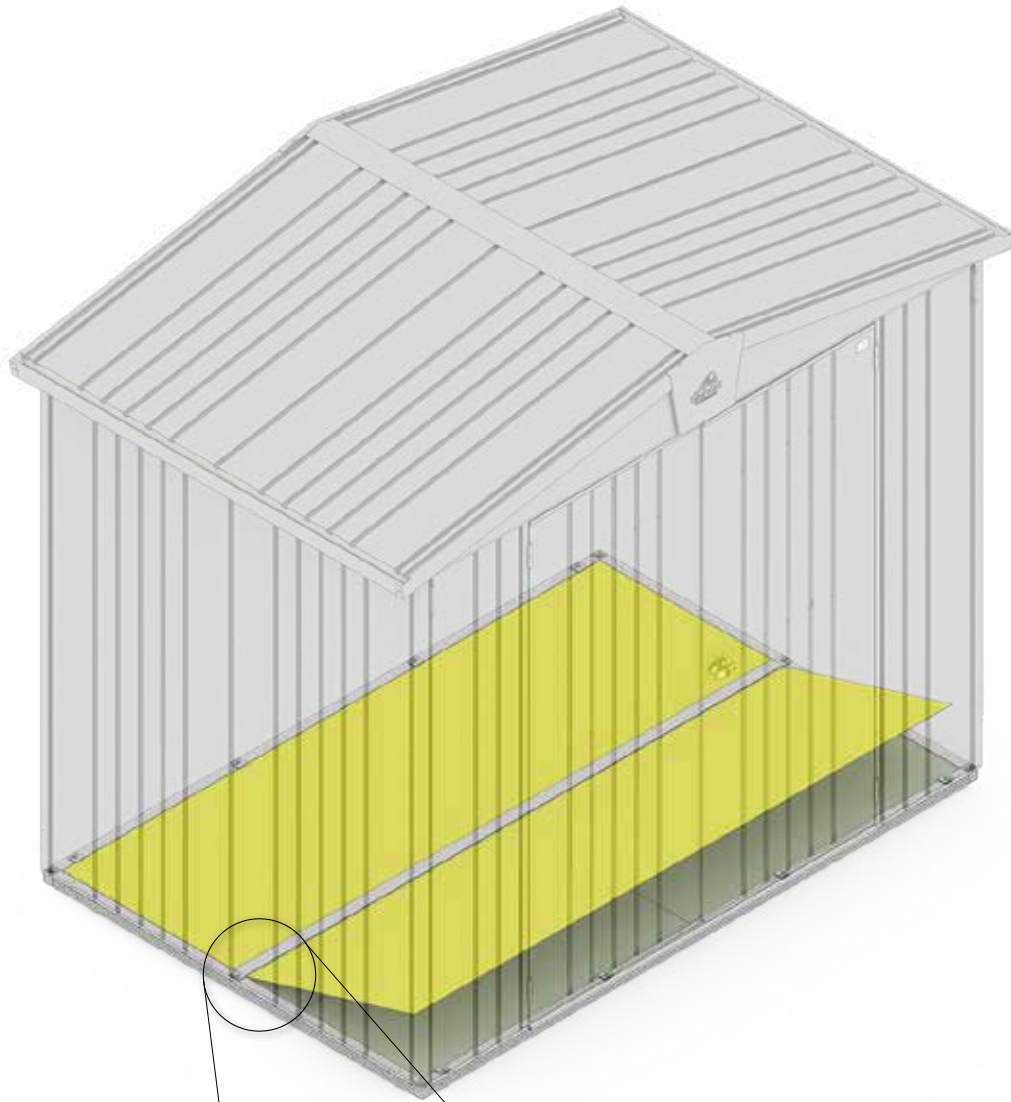

Einreichplan
für die Aufstellung eines
Biohort-Gerätehauses
Modell „Europa“

Approval plan
for the erection of Bio-
hort garden shed
model "Europa"

Demande
d'autorisation pour la
mise en place d'un abri
de jardin Biohort modèle
« Europa »

**Plan van
goedkeuring**
voor het bouwen van
het Biohort tuinhuis
model "Europa"

Adresse Aufstellort / Address at site of erection / Adresse du terrain / Platsingsadres

Grundbuch-Einlagezahl
Land register-Site No. / Cadastre
Katastralgemeinde

Grundstücks-Nr.
Property No. / Parcelle n°
Kadastraal nummer

Katastralgemeinde
Council/Borough responsible
Section/Commune / Eigendomsnummer

Bauwerber

Building applicant

Demandeur / Opbouwer

Vorname / Christian name / Prénom / Voornaam

Familienname / Surname / Nom / Achternaam

Anschrift / Address / Adresse / Adres

Unterschrift des Bauwerbers / Signature of applicant / Signature du demandeur / Handtekening eigenaar

Grundstückseigentümer

Property owner

Propriétaire du terrain

Landeigenaar

Vorname / Christian name / Prénom / Voornaam

Familienname / Surname / Nom / Achternaam

Anschrift / Address / Adresse / Adres

Unterschrift des Grundstückseigentümers / Signature of property owner
Signature du propriétaire / Handtekening eigenaar

Bodenfläche des Biohort-Gerätehauses:

Floorspace of biohort garden shed:
Surface au sol de l'abri de jardin Biohort :
Oppervlakte van het Biohort tuinhuis:

- o Größe 1 / Size 1 / Taille 1 / Grootte 1 = 1,22 m²
- o Größe 2 / Size 2 / Taille 2/ Grootte 2 = 2,31 m²
- o Größe 2A / Size 2A / Taille 2A / Grootte 2A = 1,80 m²
- o Größe 3 / Size 3 / Taille 3 / Grootte 3 = 3,40 m²
- o Größe 4 / Size 4 / Taille 4 / Grootte 4 = 5,02 m²
- o Größe 4A / Size 4A / Taille 4A / Grootte 4A = 4,62 m²
- o Größe 5 / Size 5 / Taille 5 / Grootte X5 = 6,63 m²
- o Größe 6 / Size 6 / Taille 6 / Grootte 6 = 6,63 m²
- o Größe 7 / Size 7 / Taille 7 / Grootte 7 = 8,76 m²

Gesamte bebaute Fläche

Total built-up area / Surface totale bâtie / Totaal bebouwde oppervlakte

Gartenfläche

Garden area / Surface du jardin / Tuin oppervlakte

Altbau bewilligt

Erection authorised by
Permis de construire du bâtiment existant sur le terrain N°
Opdracht tot opbouw door

vom

Date / En date du / Datum

Verein

Association / Société / Vereniging

Lageplan 1 : 500

Siteplan 1 : 500
Plan de masse 1 : 500
Map 1 : 500

Abmessungen Gerätehaus „Europa“ in mm

dimensions garden shed "Europa" in mm

dimensions des abri de jardin « Europa » en mm

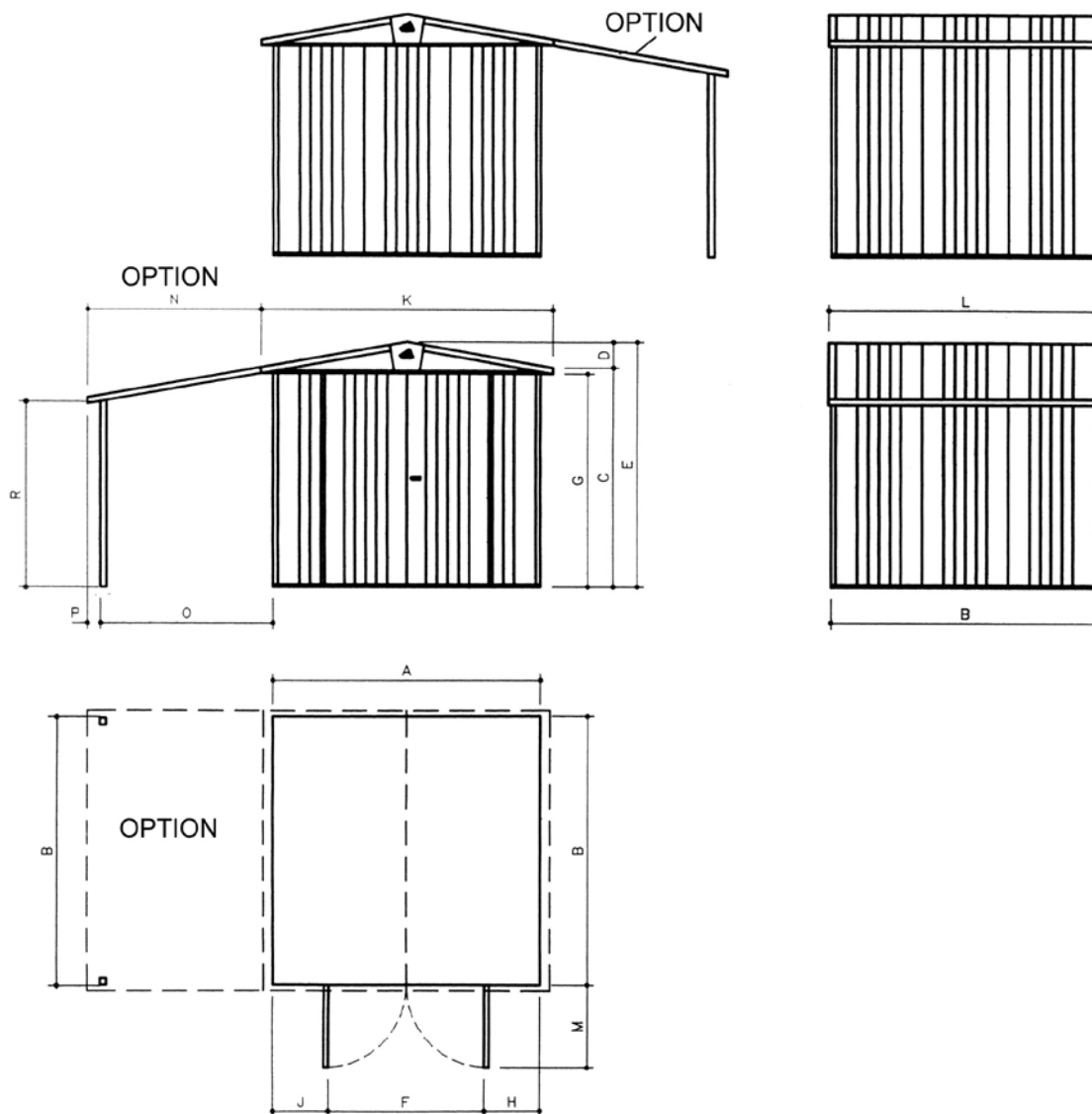

Gerätehausmaße / dimensions		Gerätehaus - Größen / sizes								
Maßbezeichnungen		Größe 1	Größe 2	Größe 2A	Größe 3	Größe 4	Größe 4A	Größe 5	Größe 6	Größe 7
Gerätehausbreite	A	1520	1520	2240	2240	2240	2960	2960	2240	2960
Gerätehauslänge	B	800	1520	800	1520	2240	1520	2240	2960	2960
Gerätehaushöhe bis Rinne	C	1810	1810	1810	1810	1810	1810	1810	1810	1810
Gerätehaushöhe Rinne bis First	D	155	155	220	220	220	285	285	220	285
Gerätehausgesamthöhe	E	1965	1965	2030	2030	2030	2095	2095	2030	2095
Durchgangslichte - Breite	F	1350	1350	1350	1350	1350	1350	1350	1350	1350
Durchgangslichte - Höhe	G	1710	1710	1710	1710	1710	1710	1710	1710	1710
Seitenbreite rechts	H	85	85	85/445/805	85/445/805	85/445/805	85/805/1525	85/805/1525	85/445/805	85/805/1525
Seitenbreite links	J	85	85	805/445/85	805/445/85	805/445/85	1525/805/85	1525/805/85	805/445/85	1525/805/85
Dachbreite	K	1720	1720	2440	2440	2440	3160	3160	2440	3160
Dachlänge	L	840	1560	840	1560	2280	1560	2280	3000	3000
Türplatzbedarf beim Öffnen	M	700	700	700	700	700	700	700	700	700
Dachbreite Seitendach	N		1445		1445	1445	1445	1445	1445	1445
Seitenbreite bis Seitendachstütze	O		1445		1445	1445	1445	1445	1445	1445
Dachvorsprung Seitendach	P		100		100	100	100	100	100	100
Durchgangshöhe seitlich	R		1560		1560	1560	1560	1560	1560	1560



GERÄTEHÄUSER – Setzen Sie auf Qualität & Langlebigkeit
GARDEN SHEDS – rely on quality & longevity



GARTENBOXEN – Outdoorboxen für Garten, Terrasse & Co.
OUTDOOR BOXES – outdoor boxes for garden, patio & more



FAHRRAD-GARAGEN – Fahrräder, Roller & Co sicher verstaut
BICYCLE STORAGE – for safe storage of bicycles, scooters & more



MÜLLTONNEN-BOXEN – Stylish, praktisch & wartungsfrei
DUSTBIN STORAGE – stylish, practical & maintenance free



GARTEN-HELFER – Gartendesign in Bestform
GARDENING HELPERS – garden design at its best

Kontrollnummer:
 Control-number / Contrôle-Qualité / Controlnummer:



Bei Reklamationen bitte anführen:
 Kontrollnummer und Artikelnummer des reklamierten Teils.

GB: In case of complaint please indicate the control-number and the number of the item, which is subject of complaint.

F: Pour toutes réclamations: prière de joindre le numéro de contrôle et le numéro d'article de la pièce litigieuse.

NL: Bij reclamaties svp doorgeven: controlnummer en artikelnummer van het desbetreffende onderdeel.



Biohort steht für
 „LEBEN IM GARTEN“

Biohort stands for
 „LIFE IN THE GARDEN“

follow us:

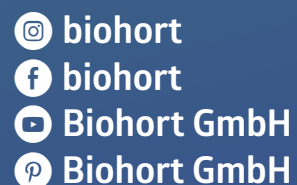

Biohort GmbH
 Pürnstern 43, 4120 Neufelden, Österreich
 Tel: +43-7282-7788-0, Fax-DW: 190
 E-Mail: office@biohort.at, www.biohort.com