

rolly[®] trac lader



rolly toys Kundendienst Deutschland:

Tel: +49 (0) 95 68 / 856-142

Fax: +49 (0) 95 68 / 856-183

e-mail: service@rollytoys.de

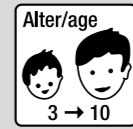

2018/09

934.000.800.00

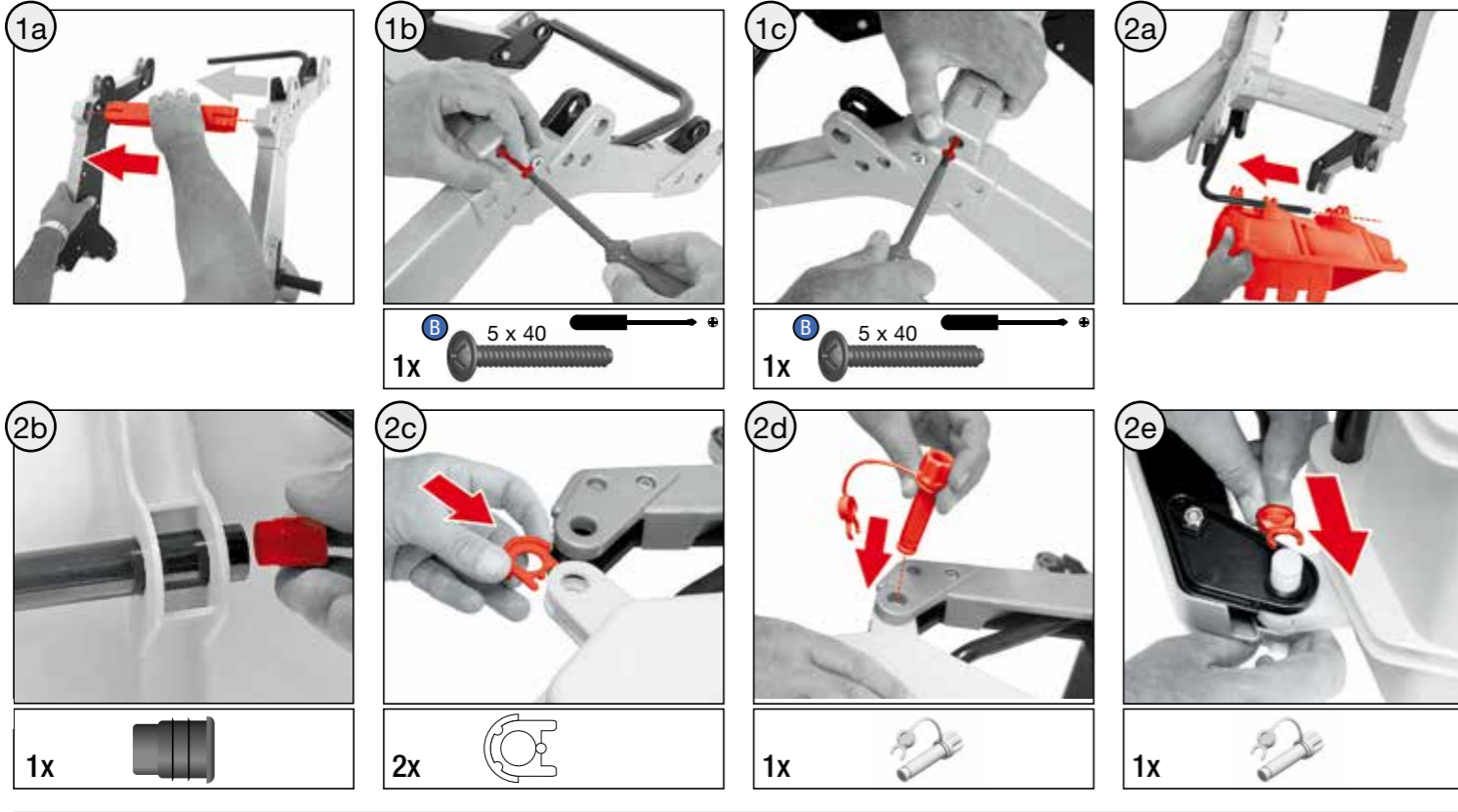

WARNING:
CHOKING HAZARD – Small parts.
Not for children under 3 years.

- CHOKING HAZARD - Small parts, Danger of being swallowed. Contains small parts in non assembled state. Must be assembled by adults.
- Toy is not suitable to carry children.
- If toy is defective stop using it, repairs may only be carried out by adults.
- Adult supervision required.
- Never use near steps, slopes, driveways, hills, roadways, alleys or swimming pool areas.
- Always wear shoes.
- Conforms to the requirements of ASTM Standard Consumer Safety Specification on Toy Safety, F 963.

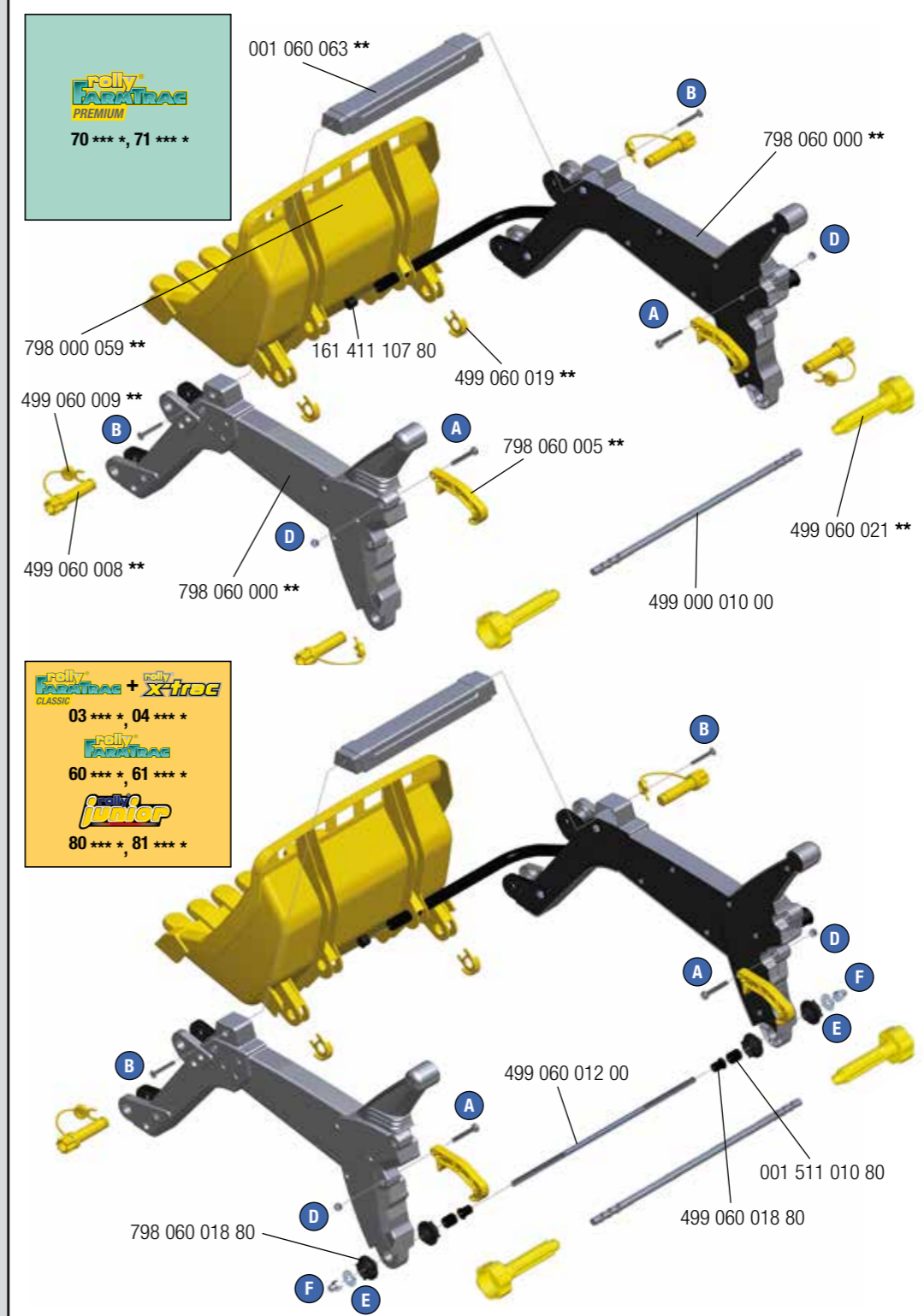
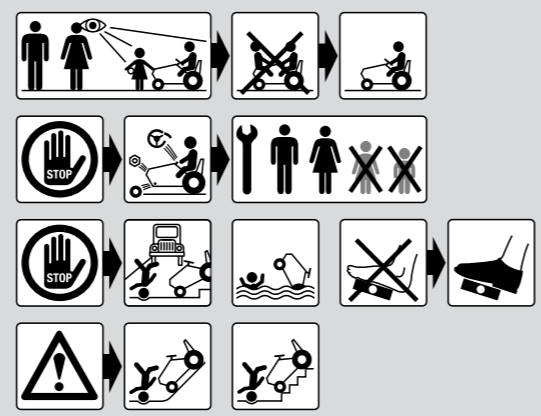

rolly[®] FABRITRAC + XTROE CLASSIC
03 *** , 04 ***
60 *** , 61 ***
rolly[®] junior
80 *** , 81 ***

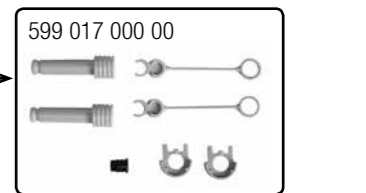
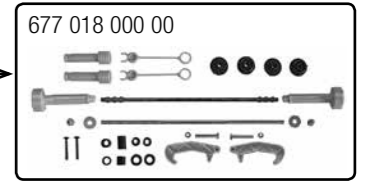

→ **

● +10	● +26	● +47
● +12	● +30	● +51
● +13	● +37	● +54
● +20	● +40	● +70
● +22	● +41	● +75
● +23	● +44	● +80

--- NORTH & SOUTH AMERICA only ---
180 days warranty
From the date of purchase + guaranteed spare part service
The warranty does not cover damages caused by improper use or neglect



made in Germany



Franz Schneider GmbH & Co KG
P.O.Box 1460
D-96459 - Neustadt bei Coburg · Germany
Tel.: +49 (0) 95 68 / 856-0
Fax.: +49 (0) 95 68 / 856-190
www.rollytoys.com

reilly FARATRAC PREMIUM
70 *** , 71 ***
(A - I)

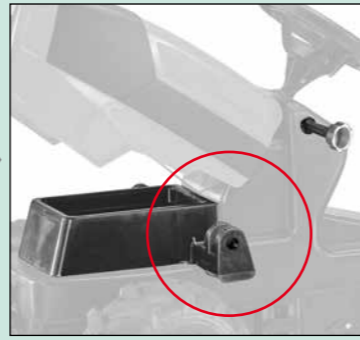
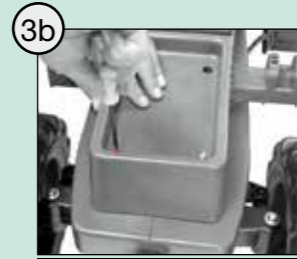
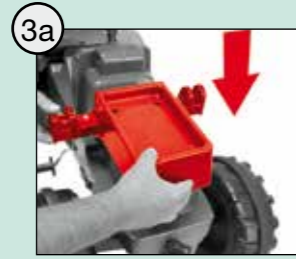

B 5 x 40
2x **C** 3 x 20

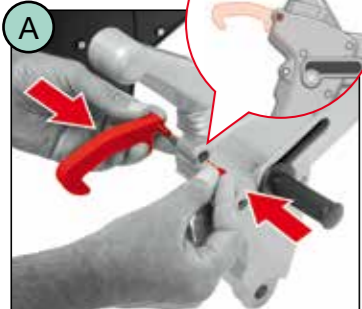

A M6 x 40
1x **D** M6

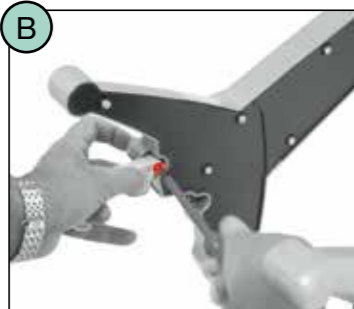

1x

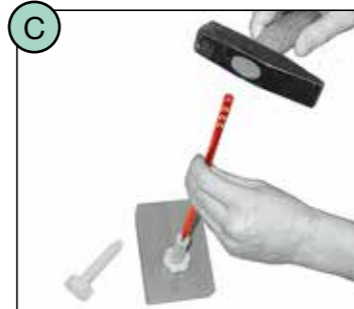

C $\varnothing 8 \times 335\text{mm}$
1x

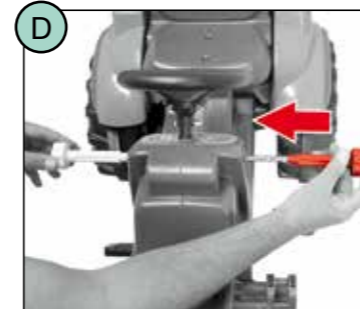

1x

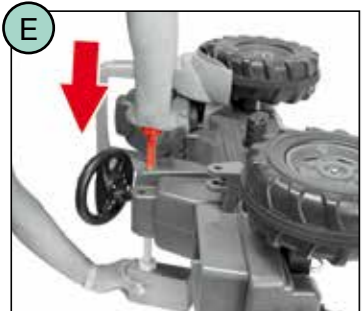

E $\varnothing 8 \times 345\text{mm}$
1x

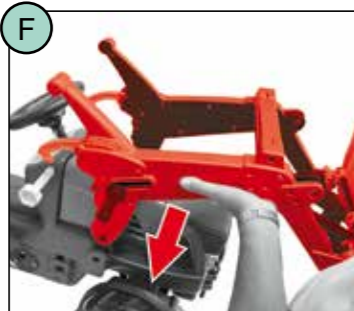

2x



2x

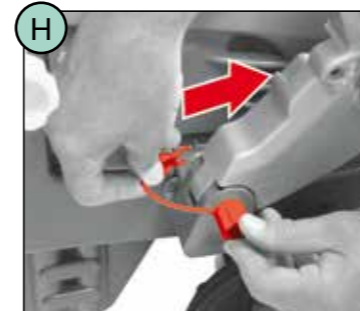

2x

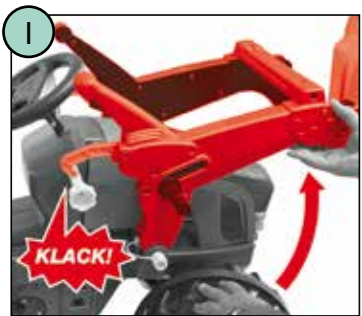

I KLACK!

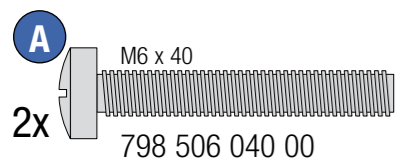

A M6 x 40
2x 798 506 040 00

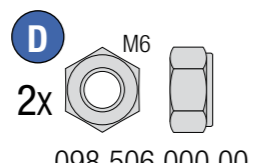

D M6
2x 098 506 000 00

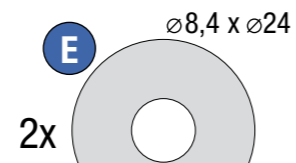

E $\varnothing 8,4 \times \varnothing 24$
2x 902 184 000 00

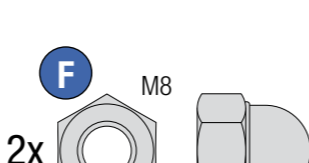

F M8
2x 098 608 000 00

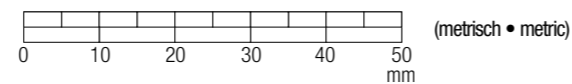

(metrisch • metric)

reilly FARATRAC + reilly XTAC CLASSIC
03 *** , 04 ***
reilly FARATRAC
60 *** , 61 ***
reilly junior
80 *** , 81 ***
(J - Z)

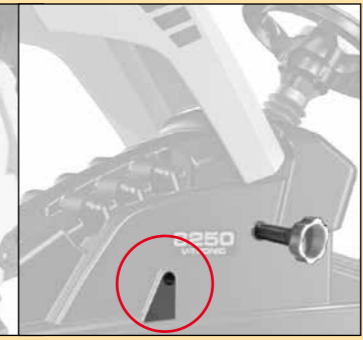
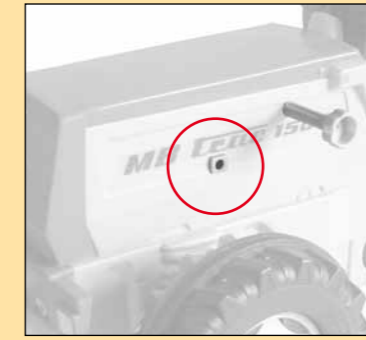

J M6 x 40
1x **D** M6

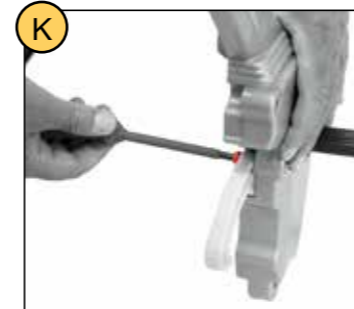

1x



L $\varnothing 8 \times 335\text{mm}$
1x

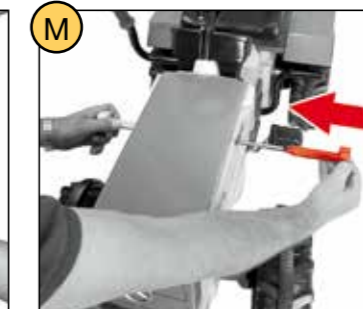

1x

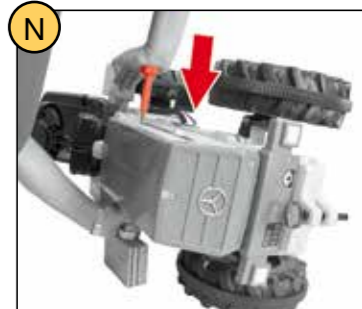

1x

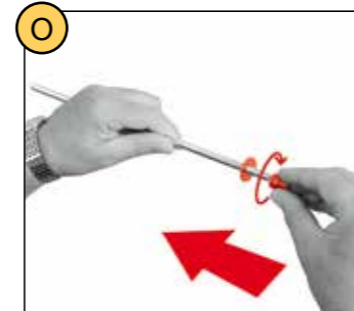

O $\varnothing 8 \times 345\text{mm}$
1x



P $\varnothing 12 \times 16\text{mm}$
2x

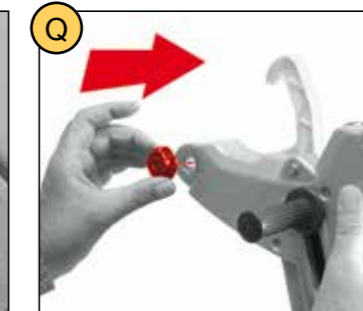

1x



1x

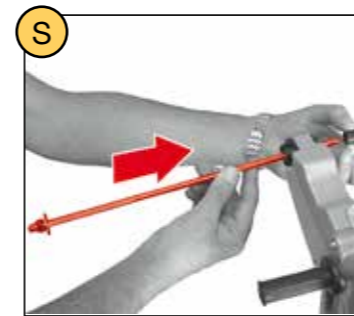

S $\varnothing 8,4 \times \varnothing 24$
1x

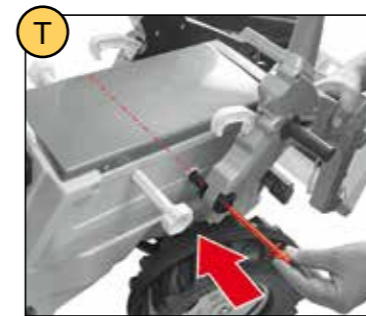

1x

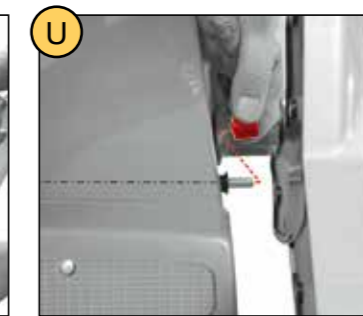

1x

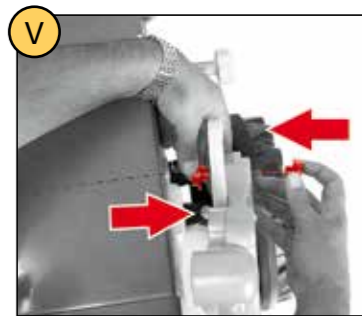

1x



W $\varnothing 8,4 \times \varnothing 24$
1x

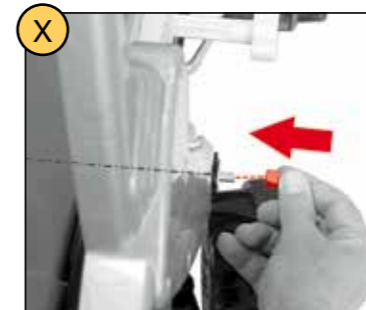

X M8
1x



Y 13
1x



Z KLACK!