

**WARNING:**  
**CHOKING HAZARD – Small parts.**  
Not for children under 3 years.

- CHOKING HAZARD: Small parts. Danger of being swallowed. Contains small parts in non assembled state. Must be assembled by adults.
- Adult supervision required.
- Never use near steps, slopes, driveways, hills, roadways, alleys or swimming pool areas.
- Always wear shoes.
- Never allow more than one rider.
- The use of protective gear and a safety helmet is highly recommended.
- Conforms to the requirements of ASTM Standard Consumer Safety Specification on Toy Safety, F 963
- Not suitable for children under 3 years.

---NORTH & SOUTH AMERICA only---

**180 days warranty**

From the date of purchase + guaranteed spare part service  
The warranty does not cover damages caused by improper use or neglect

rolly®  
**DIGGER**

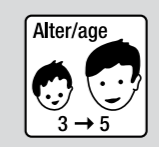

**rolly toys Kundendienst Deutschland:**  
Tel: +49 (0) 95 68 / 856-142  
Fax: +49 (0) 95 68 / 856-183  
e-mail: service@rollytoys.de



2019/03  
**100.000.800.00**

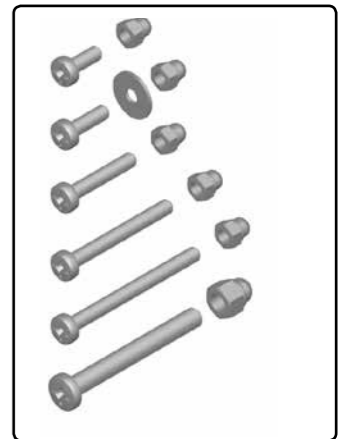
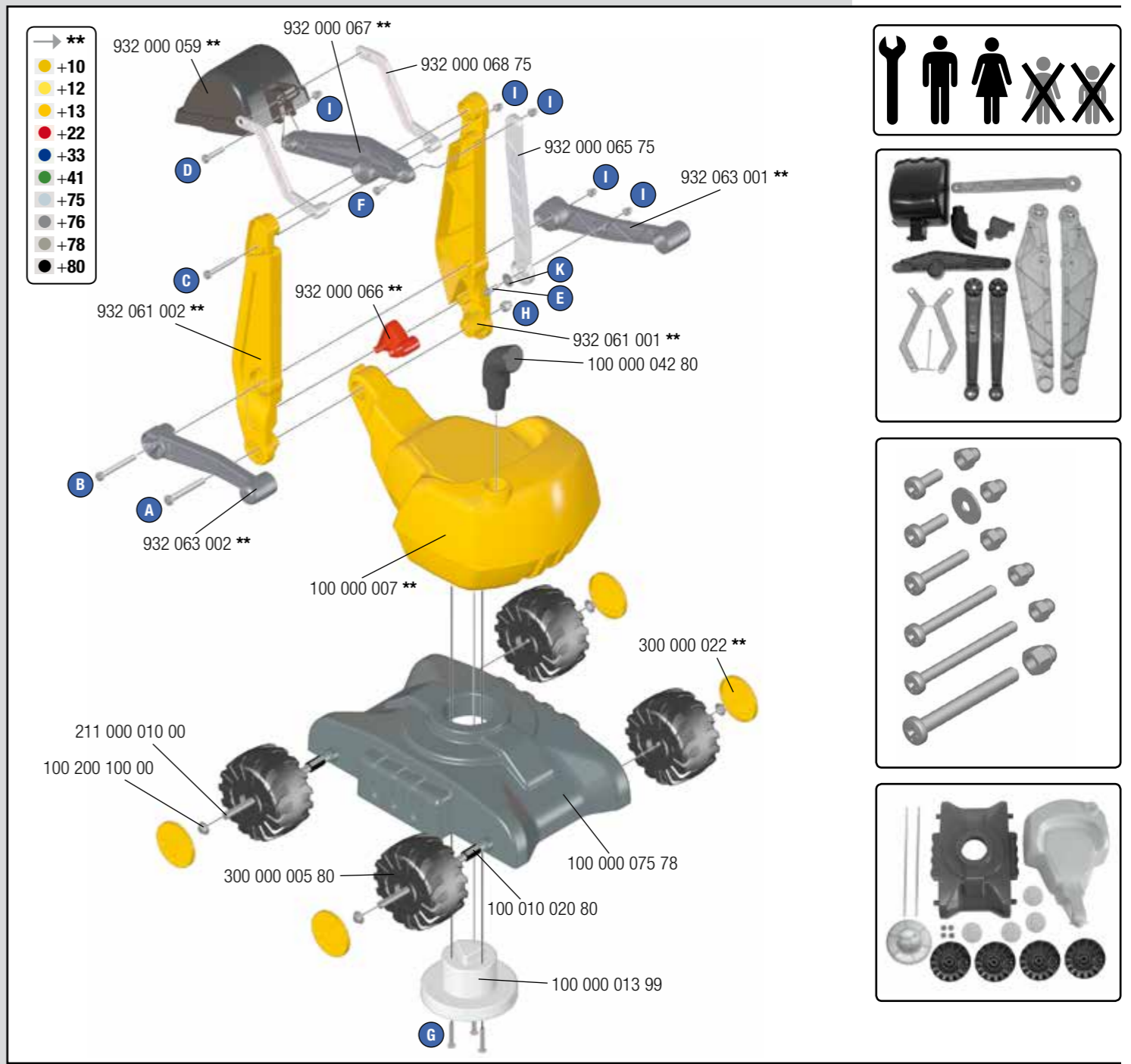

**CE**  
made in Germany

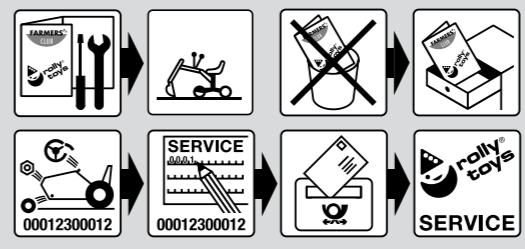

**rolly toys**  
**Franz Schneider GmbH & Co KG**  
P.O.Box 1460  
D-96459 · Neustadt bei Coburg · Germany  
Tel.: +49 (0) 95 68 / 856-0  
Fax: +49 (0) 95 68 / 856-190  
www.rollytoys.com

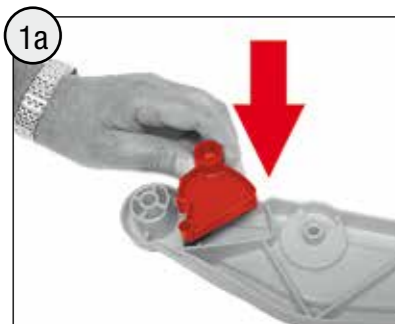

2x **A** M8 x 70



2x **H** M8



 ⊕

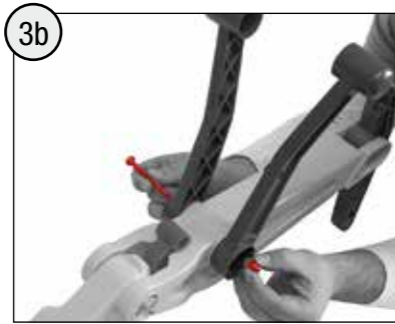
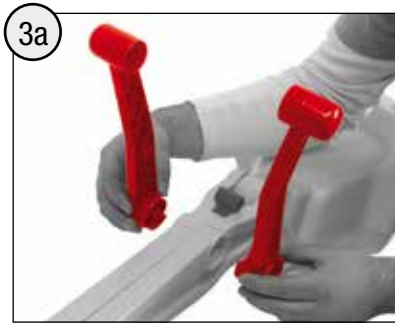
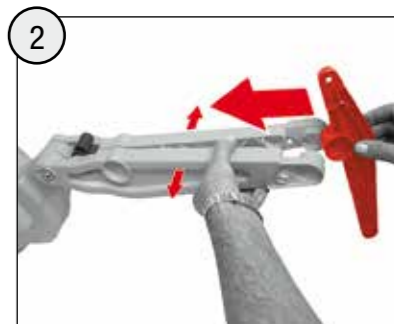

1x **B** M6 x 70 **I** M6

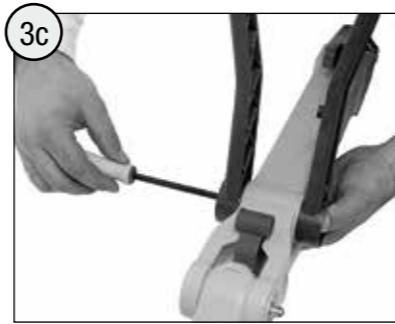

 ⊕

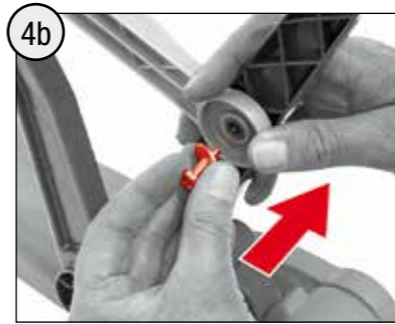

1x **E** M6 x 20 **K** ø 20

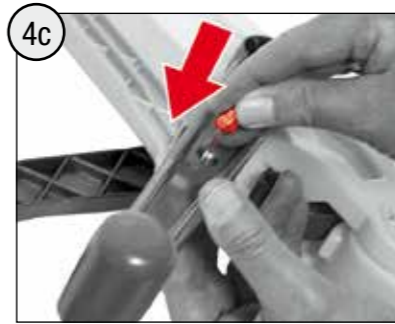

1x **I** M6

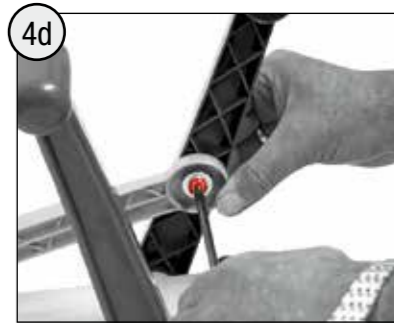

 ⊕

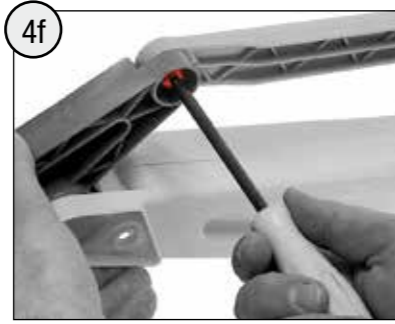
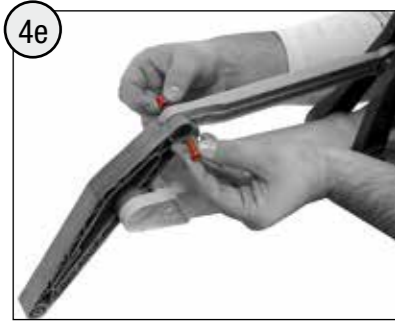

1x **F** M6 x 16 **I** M6

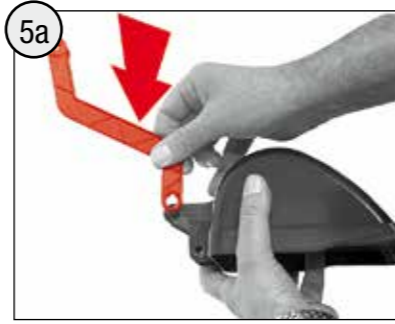

 ⊕

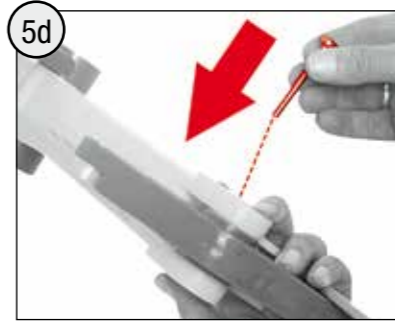
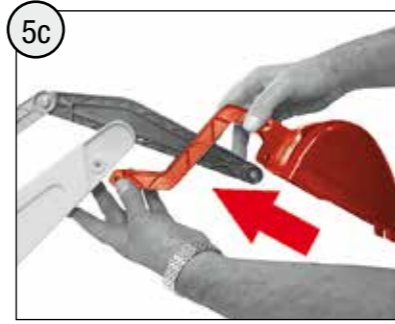
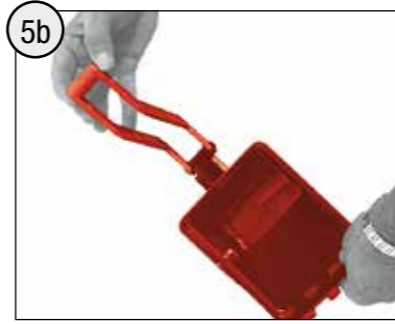

1x **C** M6 x 55

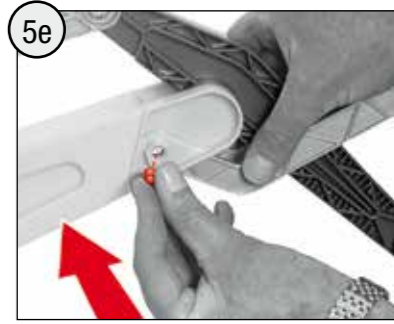

1x **I** M6

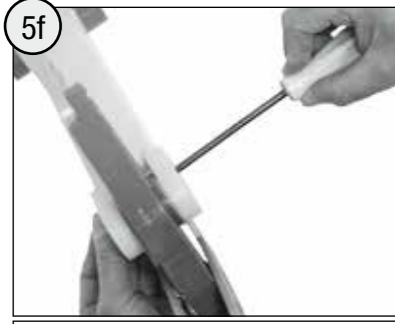

 ⊕

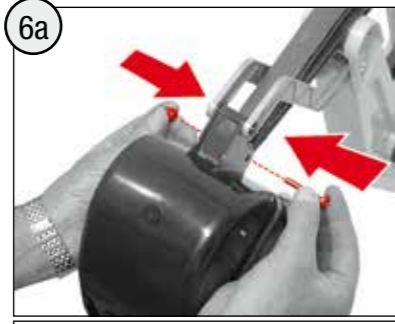

1x **D** M6 x 35 **I** M6

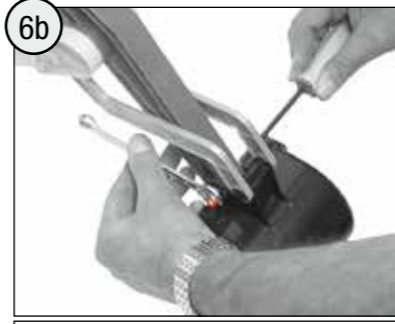

 ⊕

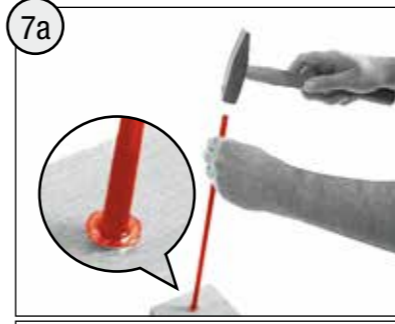

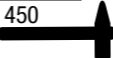
2x  ø 10 x 450 

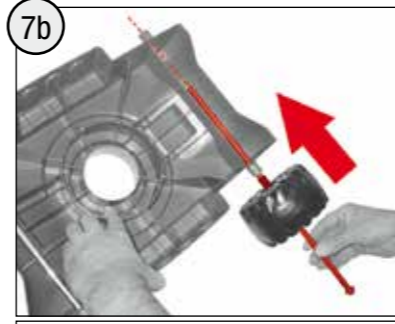

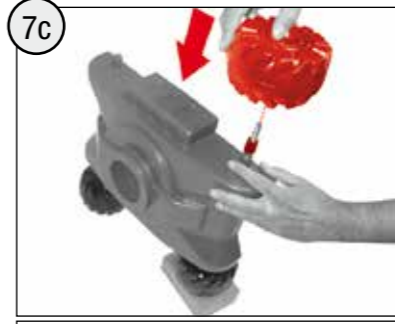

2x  ø 15 x 20

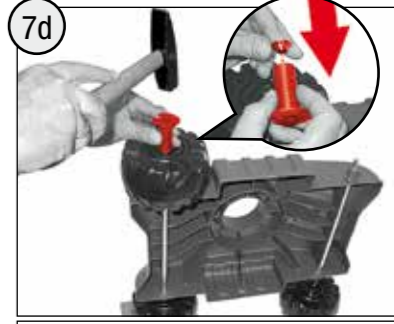

2x  ø 15 x 20



2x  



4x 

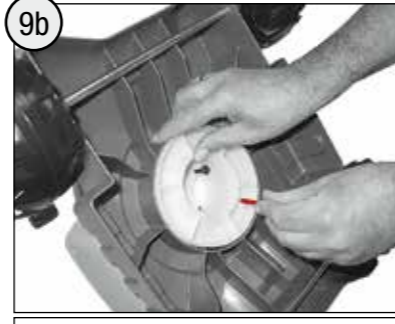

3x **G** ø 5 x 40

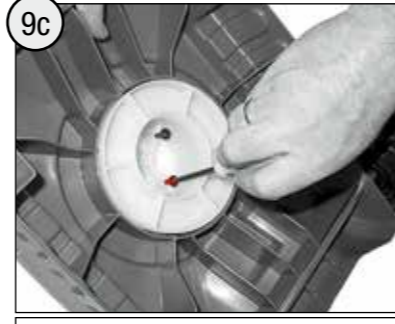

 ⊕

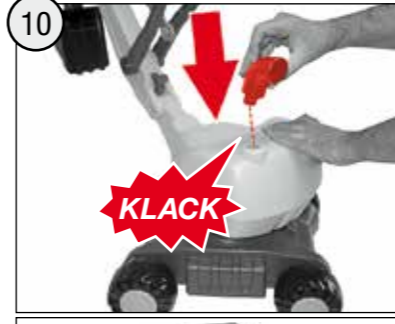

1x 